

2CV WORKSHOP

Revision 4



The Mobile Workshop! Raid Arnhem 2016

Graeme Dennes

2CV WORKSHOP

Revision 4

By Graeme Dennes

This article also applies in principle to all workshops and all vehicle brands.

Section	Page	Subject
1	3	Digital Timing Light
2	12	Phillips and Pozidriv Screws and Screwdrivers
3	15	Australia's 230V Wiring Standards and Power Tools
4	20	Wire Crimping, Crimps and Crimping Tools
5	30	Valve Overlap
6	32	Calculating Cranking Compression Pressure
7	39	Calculating Piston Drop for a Given Crankshaft Angle
8	41	Calculating Crankshaft Angle for a Given Piston Drop
9	42	The Basis of Soldering
10	50	List of articles by the Writer

1. "DIAL-BACK" DIGITAL TIMING LIGHT

Background:

Most readers will be familiar with the standard strobe timing light. Its purpose is to generate a bright flash at the moment the engine's number one cylinder spark plug fires, allowing the ignition timing point (crankshaft angle with respect to top dead centre) to be checked/set. The engine manufacturer specifies the spark plug firing angle with respect to the crankshaft's top dead centre position. *Although this article applies in principle to all vehicles*, the Citroen 2CV is used as an example. For the 2CV, the required timing marks have to be established by locking the flywheel at 8° BTDC (before top dead centre) with a 6 mm pin, then painting two white marks which are aligned: one mark on a visible flywheel tooth and the other on the adjacent gearbox casing at a point which lines up with the marked flywheel tooth. (Refer to the Engine section in the writer's article, 2CV Maintenance - Part 1 of 2 for further information on setting engine timing.) See Fig. 1-1 below which shows the two marks painted on the 2CV.

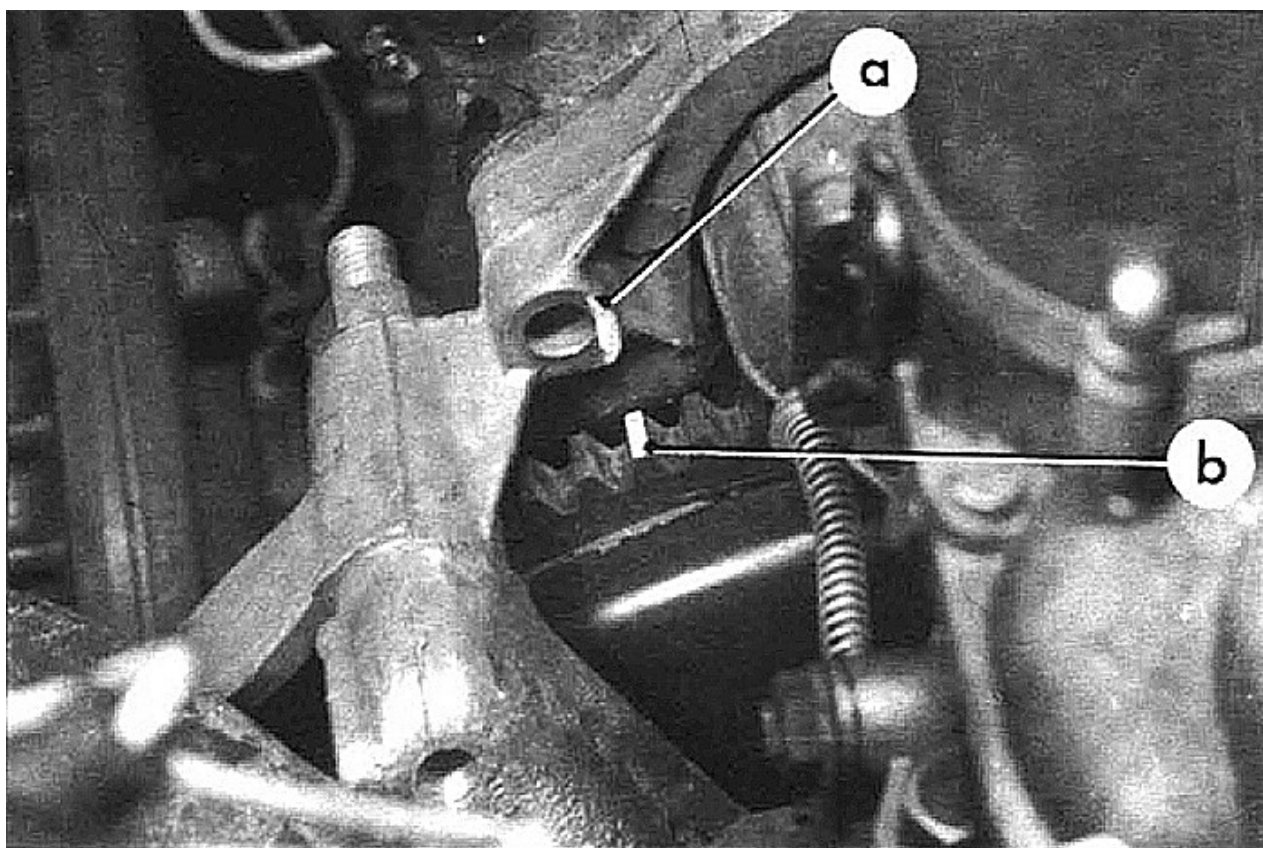


Fig. 1-1. The two painted timing marks on the 2CV engine

With the timing pin in position, mark "b" is painted on the top face of a visible flywheel tooth and mark "a" is painted on the gearbox casing at a position which is in line with the painted tooth, as shown. Thus, the two marks line up when the crankshaft is at 8° BTDC.

After removing the timing pin, start the engine and set the idle speed to 800 - 850 RPM. The engine timing is adjusted with the aid of a timing light so the two painted marks are lined up as shown in Fig. 1-1. At that point, the engine idle timing has been set according to Citroën's specifications, where the spark plugs fire at 8° BTDC at idle. **Citroën's 8161 Repair Manual page 56 states "in no circumstances should the advance be less than 8° for the M28/1 engine"**.

Why do we set the engine timing so carefully? When the spark plug fires, the fuel mixture is ignited, and the flame front travels smoothly and evenly throughout the mixture. *Maximum energy* is extracted from the burning fuel at an optimum crankshaft angle *just after* top dead centre. Obtaining maximum energy from the fuel means maximising the integral of the combustion pressure with respect to time to apply maximum torque to the crankshaft.

What about ignition timing at higher RPMs?

The standard timing light does a fine job in helping us set the ignition timing at idle as discussed, but it's not the only ignition timing aspect of the 2CV engine. Citroën also specifies a further ignition timing requirement: an *additional* 25° of advance is required at 3000 RPM, which is achieved using centrifugal weights fitted to the end of the camshaft extension which rotate the points cam. In operation, the camshaft turns and drives the points cam via the two springs. As the engine turns faster, the inertial forces of the weights on the springs force the springs to bend outwards, and in doing so, the effective length of the springs is shortened, causing the points cam to rotate anti-clockwise with respect to the camshaft, which causes the points to open earlier in the cycle. There are two metal stops that define the limit of travel and therefore total advance of the ignition timing.

In any given situation, the fuel mixture burn time is essentially independent of engine RPM, so as the RPM increases, the firing of the spark plug has to occur earlier to provide sufficient time for the mixture to burn and apply maximum pressure on the piston at the optimum point. The job of the centrifugal weights is to advance the ignition timing as the RPM increases to provide the necessary ignition advance. (As an aside, the centrifugal weights in points ignition systems are a critical component in the performance of the 2CV engine, yet sometimes, insufficient attention is given to their serviceability status.) The centrifugal weights have negligible effect below 1000 RPM, so have no effect on the ignition timing at idle speed. Refer to the Citroën data pages at the end of this section for details of the ignition advance characteristics specified for the centrifugal weights of the 2CV.

However, the standard timing light has a key shortfall: it is unable to be used to check/set the *additional* timing advance of 25° at 3000 RPM. This is because we can no longer observe the flywheel tooth with the painted mark on it because the tooth is located 25° *anti-clockwise* from the painted mark on the gearbox casing, where it is hidden from sight by the engine casing when the strobe light flashes. It can't be seen.

Some owners try to overcome the inability to see the timing mark by placing an *additional* paint mark on the flywheel. The 2CV flywheel post-1970 (the M28/1, 602cc engine) has 107 teeth. Thus an extra 25° of advance (at 3000 RPM) is then equivalent to $25 / 360 \times 107 \text{ teeth} = 7.4305 \text{ teeth}$, so a second paint mark is made on the flywheel at a position **7.4305** teeth *clockwise* from the tooth with the 8° BTDC mark. This second mark is used with the timing light at 3000 RPM to line up with the gearbox casing mark. Sounds fine in theory, but achieving timing *accuracy* with this method is challenging! As we don't want any error in ignition timing at 3000 RPM, don't count 7.4305 teeth! It's too problematic and therefore carries some risk for the engine.

Another option is to *accurately* place a *small mark* on the flywheel at a position 25° *clockwise* from the 8° mark after the flywheel is removed from the engine and placed on the work bench. This will provide a correctly positioned timing mark to line up with the gearbox casing mark at 3000 RPM, as we seek. However, removing the flywheel for the sole purpose of placing such a mark may not be considered as a high priority task!

In summary, are we expected to have faith that the centrifugal weights are doing their job? Well, perhaps we had to take that approach in the past by necessity when we had no other practical, accurate option, but today, the world has changed. Da, da-dah!

There is an easy solution, he says knowingly!

Take an example where the engine is running at 3000 RPM and the spark plug is firing at 33° BTDC. Now, here is the magic! If we were able to dial back or *delay* the strobe flash by 25° of crankshaft rotation *after* the spark plug fires, the strobe will flash at the point the two painted timing marks are lined up, just as they are at idle. Thus, the angle of advance being applied by the centrifugal weights, 25°, is measured by the angle we have needed to delay the strobe flash by, 25°. Eureka!

An Example of a Modern Digital Timing Light:

The writer uses the Innova 5568 professional digital timing light shown [here](#). This is a modern hand-held “dial-back” digital timing light which displays engine RPM, advance angle, dwell and battery voltage. Refer to the following figures.



Fig. 1-2. Example of a modern digital “dial-back” timing light



Fig. 1-3. Control panel showing 25° of advance at 2230 RPM.

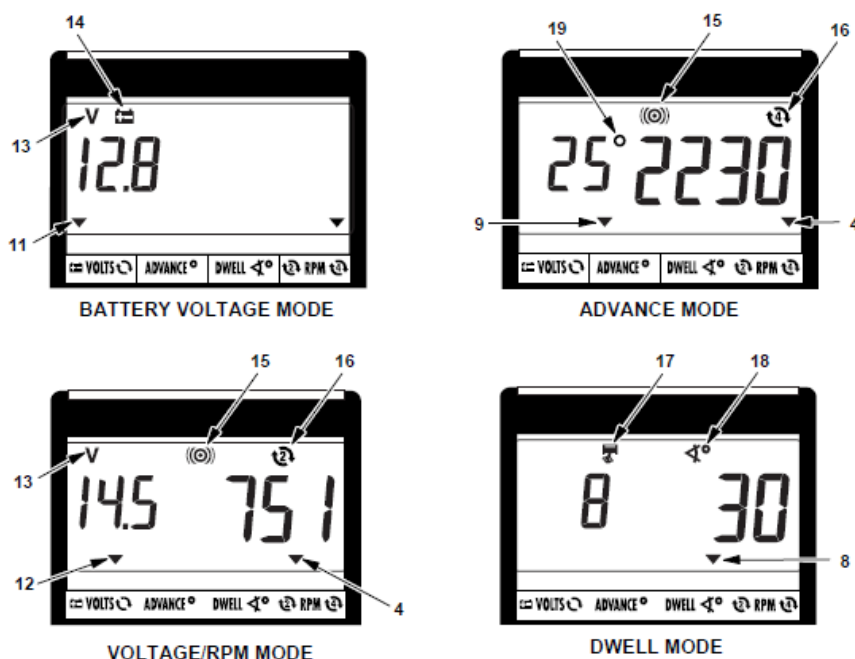


Fig. 1-4. The four operating modes (from the manual).

Please note: This is not intended as an endorsement for this timing light. It just happens to be the timing light used by the writer and is included here for informational purposes. There are numerous “dial-back” digital timing lights available today.

Plots of the Timing Angles, using the 2CV as an example:

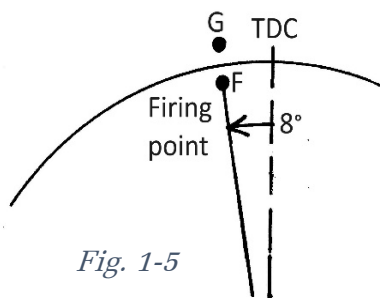


Fig. 1-5

Fig. 1-5 at left shows the positions of the timing marks at 800 – 850 RPM (idle), with the ignition timing point (spark plug firing point) set at a crankshaft angle of 8° BTDC, where the two timing marks are shown lined up by the timing light strobe flash. This is the standard timing setting for the 2CV.

G is the timing mark painted on the Gearbox casing.

F is the timing mark painted on the Flywheel tooth.

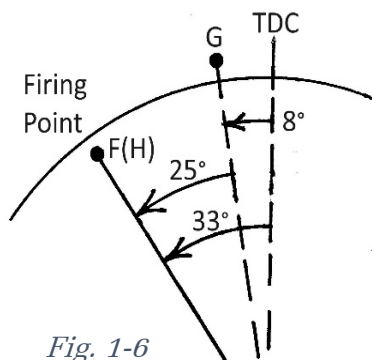


Fig. 1-6

Fig. 1-6 at left shows the positions of the timing marks at 3000 RPM, where the centrifugal weights have advanced the ignition timing by a further 25°, causing the spark plug to fire at a crankshaft angle of 33° BTDC.

The timing mark on the flywheel, F, has moved to position F(H), with the H indicating the flywheel mark is *hidden* from sight by the engine casing, unable to be observed with the standard timing light strobe flash, so we cannot identify the exact position of the mark F(H). However, even if we *could* see its position, what we are really seeking, the *raison d'être* for this exercise, is to *measure* the angle of advance being applied by the centrifugal weights, currently shown as 25° in the figure. *That* angle is the angle we seek to measure. Mmm. All good so far.

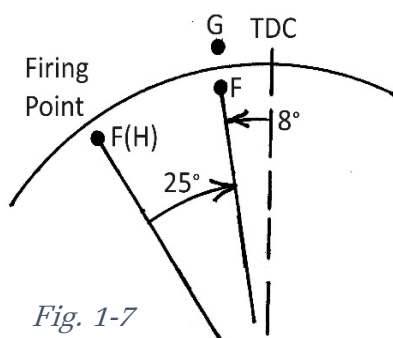


Fig. 1-7

Fig. 1-7 at left shows the results when using a **digital** timing light, which is incrementally adjusted by the operator to *delay* the strobe flash by 25° of crankshaft rotation. Although the spark plug *fires* at a crankshaft angle of 33° BTDC, we delay the strobe flash by 25° of crankshaft rotation, allowing the hidden mark at F(H) to

be “walked” back to its original position at F by repeatedly pressing the timing light increment button until, once again, we can observe mark F lined up with mark G **under the strobe flash**. The advance angle readout on the timing light, 25°, is the angle of advance being applied by the centrifugal weights. Now we know!

In summary, by using a digital timing light, the crankshaft angle of *delay* applied to the strobe flash by the operator is then equal to the crankshaft angle of *advance* applied by the centrifugal weights. Once the two timing marks, F and G, are again lined up as in Fig. 1-7, the timing light’s “advance” angle readout figure indicates the advance angle being applied by the centrifugal weights. The effects of the springs, weights and limit tabs of the centrifugal weights *can now be fully known*, as can the electronically generated timing advance provided by an electronic ignition. By this means, the ignition timing point (crankshaft angle) may be determined for *any* engine RPM between idle and the recommended maximum engine RPM *for engines fitted with either centrifugal weights or fully electronic ignition units*, with the aid of the “dial-back” digital timing light.

In the above example, the advance angle figure showing on the timing light control panel will be 25°, and the RPM figure showing will be 3000, which tells us the centrifugal weights are providing 25° of advance at 3000 RPM, exactly as specified by Citroen. We can measure it *exactly!* The digital timing light has pulled the painted flywheel tooth “out of the dark” from behind the engine casing, to where it can be seen, and all observed and measured in real time.

As further information, the 33° of advance is applied so that maximum crankshaft torque is realised just after the piston reaches top dead centre. We definitely don't want the maximum pressure from the fuel burn to occur before top dead centre, as we don't want a damaged conrod or piston! Further, if the ignition timing is too advanced, it results in detonation (pinging) from the uncontrolled combustion. This can create high pressure spikes in the combustion chamber, placing additional stress on the conrod and the piston crown. Over time, this stress can contribute to conrod and/or piston failure. Use the digital timing light for accuracy, convenience AND safety of your engine!

Using the Writer's Innova 5568 Digital Timing Light with the 2CV:

1. With the 6 mm timing pin fitted in place, check that the two painted timing marks are clearly visible and in line, per Fig. 1-1.
2. Remove the timing pin.

Do not connect or disconnect the timing light when the ignition is on or the engine is running!

3. Connect the timing light battery leads to the battery.
4. Clamp the inductive pickup around a spark plug lead. *Ensure the jaws are fully closed around the plug lead and the arrow points towards the spark plug.* (If you find the subsequent strobe flash is not smooth in operation, change the inductive pickup clamp to the other plug lead.)
5. **Start the engine.** Allow it to idle at 800-850 RPM.
6. Adjust the ignition timing so the two timing marks are lined up per Fig. 1-1. This sets the engine timing to 8° BTDC at idle.
7. Increase the engine speed to 3000 RPM with the help of an assistant. This will cause the centrifugal weights to take effect and advance the timing by perhaps a further 25°.
8. Select Advance Mode on the timing light, then continue to press the increment button until the two timing marks are lined up per Fig. 1-1. The increment button increases the Advance angle on the control panel in 1° steps. Press the decrement button to reduce the Advance angle.

Note: When the Advance Mode is selected, the Advance angle showing on the control panel starts off at 0° to prevent any confusion.

9. With the two timing marks (again) lined up, read off the Advance angle and the RPM showing on the timing light control panel. Hopefully it is showing an Advance angle of 25° at an RPM of 3000. If so, the centrifugal weights are performing their duty correctly.

10. Stop the engine.

11. Disconnect the timing light (in that order).

Checking the Ignition Advance Characteristics:

The digital timing light can check:

1. The *mechanical* advance characteristics of the centrifugal weights, as used with the standard points ignition system or as used with some electronic ignition systems which use the weights.
2. The *electronic* advance characteristics built into some electronic ignition systems. These do not use the centrifugal weights. They replicate the action of the centrifugal weights electronically so as to increase the timing angle as the engine RPM increases, such as is done in the 123ignition units.

The timing light control panel presents the advance angle being applied at the measured engine RPM, allowing us to check it against Citroën's specifications (at the end of this section.)

Refer to Curve C for the M28/1 engine. Note: The curves refer to the 2CV Distributor (*camshaft*) advance angle, which is the points cam advance angle, so the advance angles and RPM figures in the curves must be *doubled* when referring to the *crankshaft* because of the 2:1 ratio of crankshaft speed to camshaft speed in the four-stroke petrol engine.

It is similarly easy to plot the advance angle at various engine speeds between 1000 and 3000 RPM, perhaps in 500 RPM steps, and check how the ignition timing advance varies due to the centrifugal weights in your 2CV compared with Citroen's specifications for Curve C.

The writer chooses the comfortable median line through the Curve C data and considers 2.5° of advance at 1000 crankshaft RPM and 25° of advance at 3000 crankshaft RPM to be safe and reliable figures for operating the 2CV engine.

Calculating the Strobe Flash Delay Time:

We'll show how the digital timing light calculates the required *time delay* before flashing the strobe so the strobe flash occurs at the required *crankshaft angle* after the spark plug fires. The digital timing light is able to calculate the required delay time because it constantly measures the engine RPM and uses it in the calculations which follow.

As an example, with an idle speed of 800 RPM, 800 crankshaft revolutions take 1 minute,

so 1 revolution of the crankshaft takes 1/800th of a minute or $60 / 800$ seconds.

As 1 revolution = 360°, then 360° of crankshaft rotation also takes $60 / 800$ seconds

So 1° of crankshaft rotation takes $60 / 800 / 360$ seconds

$$= 1 / 800 / 6 \text{ seconds}$$

$$= (1 / \text{RPM} / 6) \text{ seconds for any RPM.}$$

So to delay the strobe by 1° of crankshaft rotation, we delay it by $1 / \text{RPM} / 6 \times 1$ seconds.

To delay it by 5° of crankshaft rotation, delay it by $1 / \text{RPM} / 6 \times 5$ seconds.

To delay it by 25° of crankshaft rotation, delay it by $1 / \text{RPM} / 6 \times 25$ seconds.

In summary, the *time* required to delay the strobe flash *after* the spark plug fires is calculated automatically by the timing light as above. It's based on the measured engine RPM and the advance angle entered by the operator. This causes the strobe to flash at some crankshaft angle *after* the spark plug fires, such that the two painted timing marks can once again be showing as aligned under the strobe flash.

Conclusion:

The modern “dial-back” digital timing light is a most useful workshop tool which does much more than the traditional standard timing light. During each annual service on your vehicle, use it to perform a quick check on the operation of the engine’s ignition advance characteristics per the manufacturer’s specifications. It’s a vital check on the engine’s health and safety and only takes a couple of minutes.

For vehicles whose engines are fitted with vacuum advance devices, the operation of the vacuum devices can be checked with the digital timing light by referring to the vehicle manufacturer’s ignition timing specifications and testing procedures. Check the settings using the digital timing light, based on the principles described here.

CHARACTERISTICS

DISTRIBUTOR.

Make : DUCELLIER or FEMSA.

Type of engine	Type of vehicle	Date produced	Initial advance	Advance curve	Maximum centrifugal advance	Centrifugal advance check with device 1692-T Needle in ZONE
A 53 (425 cc)	AZ (series A and AM)	3.1963 → 2.1970	12°	A	6° to 8°	« AZB »
	AZU	3.1963 → 8.1967				
A 79/0 (425 cc)	AZU	8.1967 → 3.1972	12°	B	7°30' to 12°30'	Between «AZB» and «AZP»
	AYA (series A and AM)	8.1967 → 3.1968				
A 79/1 (435 cc)	AYA2 (series A and AM)	3.1968 → 2.1970	12°	C	10° to 15°	« AZP »
	AZ (series A 2 and KB)	2.1970 → 9.1978				
	AZU	8.1972 → 2.1978				
M 4 (602 cc)	AYA 3 (series A and AM)	1.1968 → 10.1968	12°	A	6° to 8°	« AZB »
	AK and AMI 6	→ 5.1968				
M 28/1 (602 cc)	AYB (series A and AM)	10.1968 → 2.1970	8°	C	10° to 15°	« AZP »
	AZ (series KA)	2.1970 →				
	AY (series CA)	10.1968 →				
	AK (series B)	5.1968 → 7.1970				
	AK (series AK)	7.1970 → 2.1978				
	AY (series CD)	2.1978 →				
M 28 (602 cc)	AMI 6	5.1968 → 3.1969	8°	C	10° to 15°	« AZP »
	AY (series CB)	2.1970 →				
	AMI 8 All types	3.1969 →				

Contact breaker gap : 0.35 to 0.45 mm (.014 to .018 in).

Dwell angle :

- Distributors fitted up to February 1970 : 144° ± 2° (Dwell ratio : 80 % ± 2 %)
- Distributors fitted since February 1970 : 109° ± 3° (Dwell ratio : 60 % ± 2 %)

COILS :

Make : DUCELLIER

- 6 Volt circuit : Reference 2768 - 12 Volt circuit : Reference 2769

Make : FEMSA

- 12 Volt circuit : Reference BC 12-4.

SPARKING PLUGS.

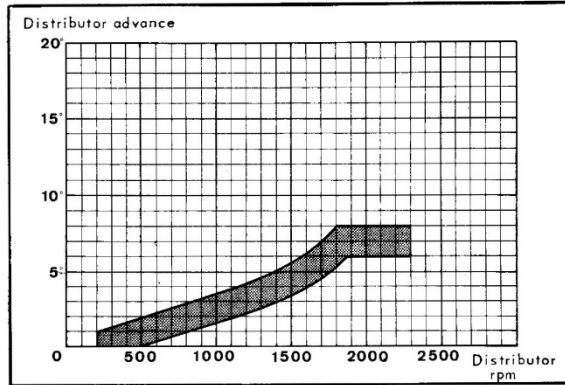
Refer to the Technical Bulletins, appearing periodically, for recommendations as to the type and make of sparking plugs to be used.

CONDENSER.

Capacity : 0.18 to 0.28 μ F.

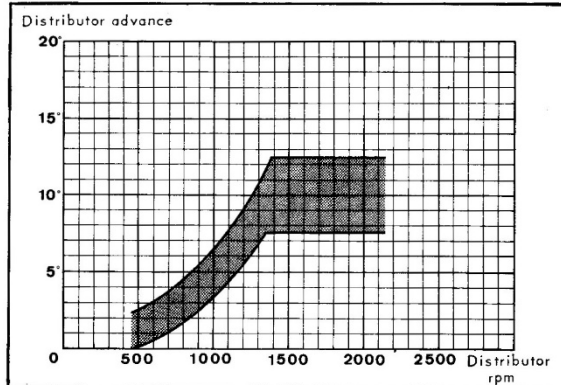
CENTRIFUGAL ADVANCE CURVES.

A. 21-54



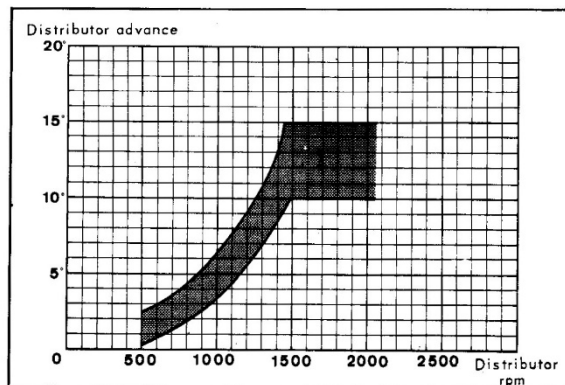
← CURVE A

A. 21-52



← CURVE B

A. 21-53



← CURVE C

2. PHILLIPS AND POZIDRIV SCREWS

Phillips and Pozidriv Screws: What's the Difference?

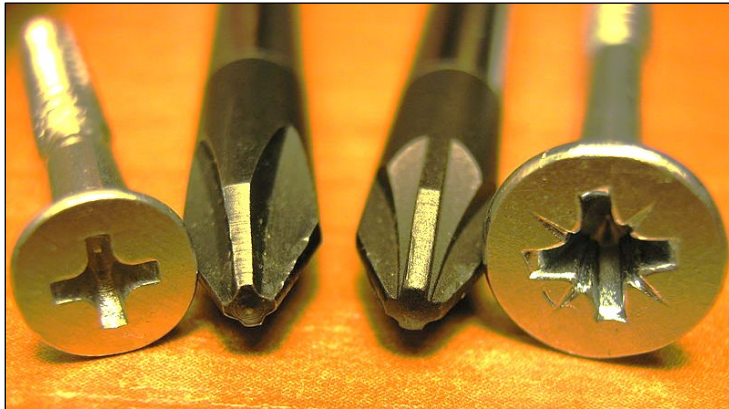


Fig. 2-1

In Fig. 2-1 at left, the screw and screwdriver tip on the left are Phillips, while those on the right are Pozidriv. These are known as 'cross-head' types.

Have you tried to use a 'cross-head' screwdriver on a 'cross-head' screw and found that, to your frustration, the screwdriver kept slipping?

The reason could be because there are two different types of cross-head screws. They look similar, but are actually different. The two types are the Phillips and Pozidriv.

The difference between Phillips and Pozidriv:

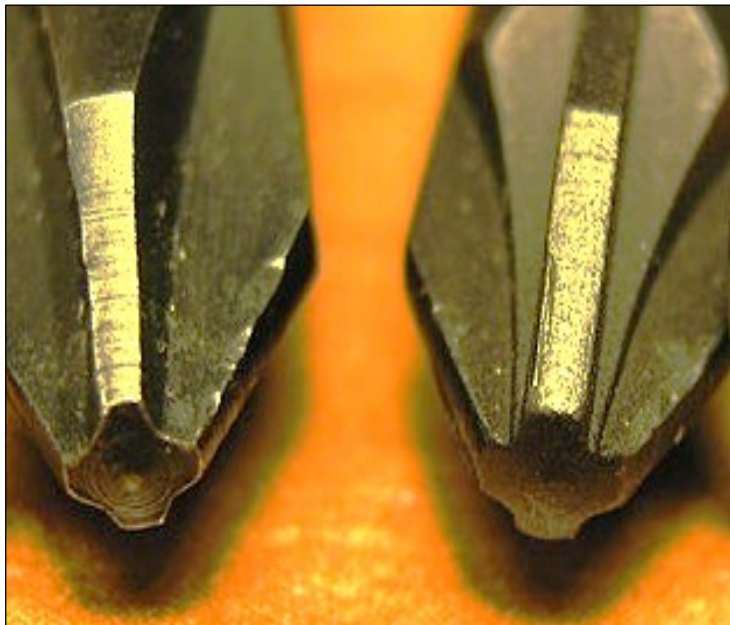


Fig. 2-2

Fig. 2-2 at left shows a close-up of the screwdriver tips in Fig. 2-1. The Phillips is on the left, showing the tapered or conical flanks (sides).

The Pozidriv is on the right, showing the parallel flanks (sides).

How to instantly identify a Phillips vs Pozidriv screw:

The easiest way to know whether a screw is Phillips or Pozidriv is that Pozidriv screws have lines etched on the screw head between the four arms of the cross, per Fig. 2-1. This visual aid means that you can instantly recognise whether a screw is Pozidriv or Phillips.

The flanks of Phillips screws and screwdrivers taper off towards the tip per Fig. 2-3. The tapered or *conical* form facilitates inserting the tip of a power-operated screwdriver in the screw head. In addition, an axial force is generated during tightening which pushes the screwdriver tip out of the screw.

In the original design, this cam-out effect was intentional and used as a torque limiter, but over time, it proved to be a disadvantage of the Phillips design.

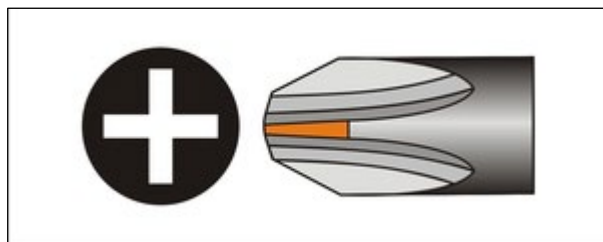


Fig. 2-3

Fig. 2-3 at left shows the Phillips screw symbol and screwdriver tip with conical flanks which taper off towards the tip. Patented in 1933.

The Pozidriv was patented in 1960 by the Phillips Screw Company and the American Screw Company, and was developed as a cross-head screw with parallel flanks to prevent the ejection force during tightening or loosening. The name Pozidriv is an acronym for "positive drive".

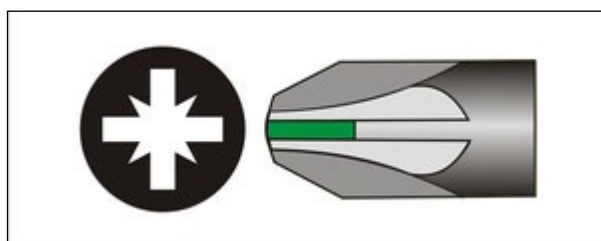


Fig. 2-4

Fig. 2-4 at left shows the Pozidriv screw symbol and screwdriver tip with parallel flanks.

Take A Closer Look at the Flanks:



Fig. 2-5



Fig. 2-6

Fig. 2-5 at left shows an enlarged view of the flanks on a Phillips screwdriver tip. Note the conical taper of the flanks.

Fig. 2-6 at left shows an enlarged view of the flanks on a Pozidriv screwdriver tip. Note the parallel flanks.

It is the conical taper of the flanks on the Phillips screwdriver and screw which generates the axial force, causing the screwdriver to cam-out and the screwdriver faces to lose contact with the screw faces.

ISO Standards:

According to ISO standards, the two cross-head types are designated as **PH** for Phillips and **PZ** for Pozidriv. These designators are typically stamped on metal parts such as screwdriver shanks and screwdriver bits, or labelled on plastic parts such as screwdriver handles.

Advantage of Pozidriv - Disadvantage of Phillips:

When applying high torque, the conical flanks of the Phillips design generate an ejection force that pushes the screwdriver out of the screw. With the Pozidriv design, the parallel flanks do not create this force.

Advantage of Phillips - Disadvantage of Pozidriv:

Phillips screwdrivers can be used for Pozidriv screws, but they do exhibit some play. Pozidriv screwdrivers, on the other hand, cannot be used for Phillips screws.

The Four Combinations:

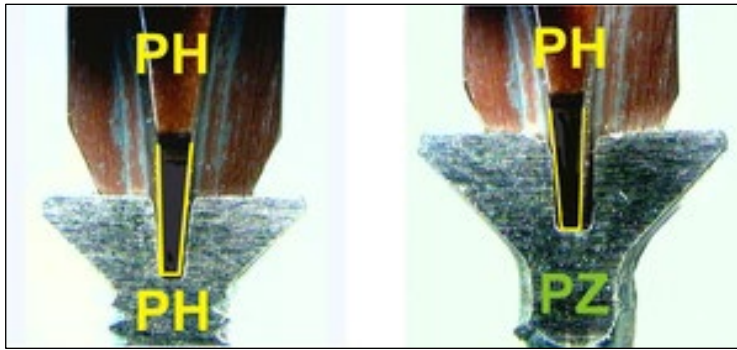


Fig. 2-7

Fig. 2-7 at left:

On left, a Phillips screwdriver in a Phillips screw. The conical or tapered form leads to ejection forces.

On right, a Phillips screwdriver in a Pozidriv screw. The conical screwdriver has play in the parallel screw.

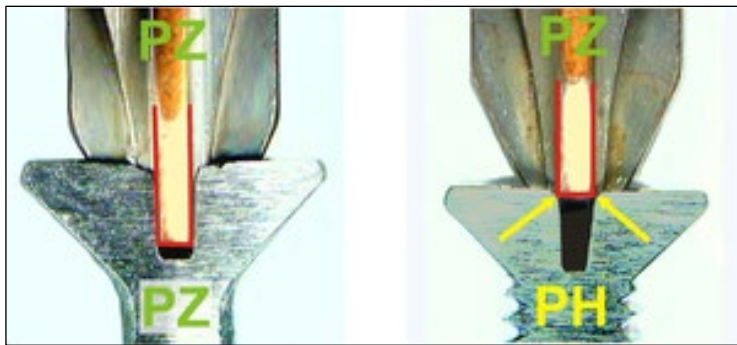


Fig. 2-8

Fig. 2-8 at left:

On left, a Pozidriv screwdriver in a Pozidriv screw. The parallel form prevents ejection forces.

On right, a Pozidriv screwdriver in a Phillips screw. The parallel tip cannot penetrate into the conical screw.

Conclusion:

A Phillips screwdriver should only be used with a Phillips screw, and a Pozidriv screwdriver should only be used with a Pozidriv screw. Be very careful to prevent slippage and damage when dealing with Phillips screwdrivers and screws in any situation!

In case of doubt, use a Phillips screwdriver. While they are not a perfect fit in Pozidriv screws, one can at least insert the correct size. The use of Pozidriv screwdrivers in Phillips screws works only with screwdrivers that are too small and easily leads to damage of the screw and/or the tool.

The Perfect Solution?

Replace Phillips screws with Pozidriv screws at **every possible opportunity**, especially in applications associated with regular maintenance activities. For reasons unknown, Phillips screws have dragged on waaaaay past their “use-by” date and should be put to rest (in the rubbish bin!).

The best part? When you remove a Phillips screw, replace it with a Pozidriv screw. Job done!

3. AUSTRALIA'S 230V WIRING STANDARDS AND POWER TOOLS

Introduction

The purpose of this section is to provide a brief introduction to Australia's 230V domestic power, its distribution, power outlets and power tool wiring, plus important safety issues.

Australia's Mains Voltage Standards History

The nominal mains voltage in Australia had been set at 240 volts since about 1926. This was later ratified under the Australian 240-volt standard AS2926 in 1987.

However, a change towards 230V began in 1980 when the International Electrotechnical Commission (IEC) decided to rationalise the 220, 230 and 240 volt voltage levels to a consistent 230 volt standard internationally. This rationalisation was intended to improve the economics of manufactured appliances by allowing manufacturers to produce appliances with only one rated voltage – 230 volts. In 1983, the IEC issued the sixth edition of its voltage standard IEC60038, which adopted 230 volts $\pm 10\%$ as the new international standard distribution voltage.

Under Australian Standard AS60038, issued in 2000, the voltage for Australia was set at 230 volts, with a +10%, -6% range, thereby allowing a voltage range between 216V and 253V. This supply is usually distributed as single-phase power using two wires – an active wire and a neutral wire. Refer to Australia's Domestic Power Installation diagram on the last page of this section. (There are still unresolved anomalies throughout Australia for the voltage standards pertaining to motors and lighting.)

(Many rural homes throughout Australia use SWER power distribution (single wire, earth return). Under this arrangement, a power pole with a single wire distributes the power to homes, with the return "wire" provided by the ground (earth) resistance.)

The Switchboard



The incoming Active and Neutral wires terminate at the switchboard. The Active wire connects to the electricity meter and then to the master switch which enables/disables the power to the premises. The master switch is mounted on the switchboard and feeds the circuit breakers (CB) and residual current devices (RCD) mounted on the switchboard. The CBs are wired into each house circuit to protect the circuit wiring from overload, and RCDs are used to minimise electric shock from contact with active wiring. Fixed appliances such as electric hot water heaters, electric cook tops and electric ovens are usually on dedicated circuits. In previous times, CBs and RCDs were manufactured as separate devices, but today, it's more usual for combination CB/RCD devices to be installed in switchboards, such as the unit shown on the left.

Let's Look Closer at RCDs

An RCD is designed as a life-saving device to prevent you from receiving a fatal electric shock should you touch something live like a bare wire. It can also provide some protection against electrical fires.

RCDs offer a level of personal protection that ordinary circuit-breakers cannot provide. An RCD is a sensitive safety device that switches off electricity automatically if there is a fault, protecting against the risks of electrocution and fire caused by earth faults.

For example, if you cut through the cable when mowing the lawn with the electric mower and accidentally touch the exposed live wire, or a faulty appliance overheats causing electric current to flow to earth, the RCD will be activated.

An RCD constantly monitors the electric current flowing through one or more circuits it is wired to protect. If it detects electricity flowing down an unintended path, such as through a person who has touched a live part, the RCD will switch the circuit off very quickly, significantly reducing the risk of death or serious injury. RCDs can help protect you from electric shock in potentially dangerous areas like bathrooms and gardens.

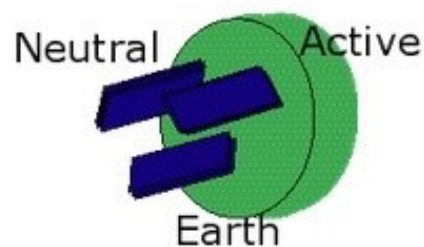
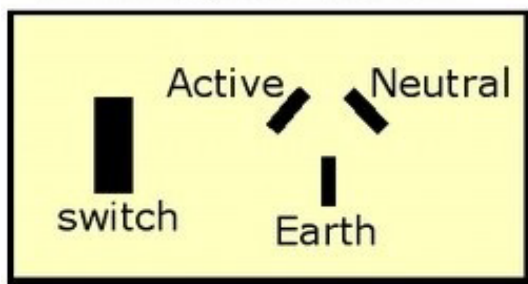
RCDs are installed in the consumer's switchboard and can provide protection to individual or groups of circuits. A fixed RCD provides the highest level of protection as it protects all the wiring and general-purpose outlets (GPO) on a circuit, and any connected appliances.

The RCD is designed to trip (turn off) at a specified current, usually 30mA. Yes, only a *very small* current is required to produce an electric shock. Keep in mind that although it may not result in death, you can receive a *severe* electric shock at a current *below* the tripping current of an RCD!

Further, an electric shock can produce strong *involuntary* muscle reactions in the body which can result in *unintended consequential* injuries to the body. You really do not want to experience that! In fact, you do not want to experience *any* electric shock!

230V 3-Pin Power Outlet Socket Wiring Standard

When viewing the standard Australian 230V 3-pin GPO as shown below, whether it be the socket in a power point, a power board or an extension cord, it has three wiring connections, named Active, Neutral and Earth as shown. The corresponding connection names are shown on the matching 3-pin plug.



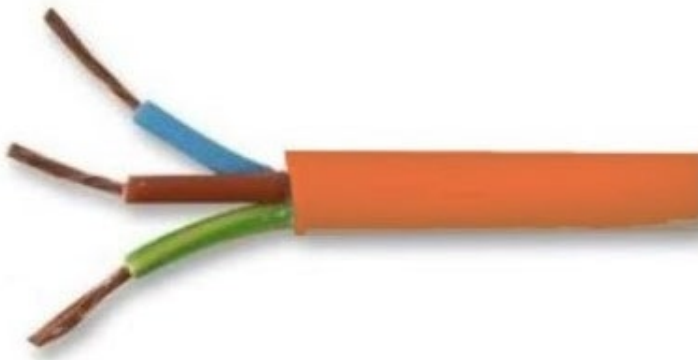
The socket connection named Active is the connection that kills. It's at an electrical potential of 230V above ground, and *you* are at ground potential! This connection layout is a most basic and important electrical standard and is one you should never forget! *Your life or someone else's life may depend on it...*

230V 3-Pin Appliance Plug Standards

When wiring up or replacing the 3-pin plug on a power tool or appliance cable, the cable connections to the plug have to take into account the connection layout of the GPO socket as above, as well as the colours assigned to the cable conductors per the paragraph following. Refer to the names of the plug pins in the diagram above and the colour coding of the cable wires below.

Ensure the plug wiring connections are correct and proper wiring practices are used. You will either know these practices *implicitly* or you won't. *There is no half-way knowledge with 230V wiring practices in regard to electrical safety!*

Australia's 230V Appliance Cable Colour Code Standard



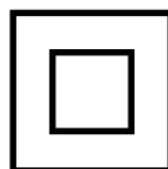
The standard 230V 3-core power cable fitted to many electrical tools, appliances, extension cords and power boards is comprised of three colour-coded, insulated, multi-strand copper conductors as shown at left. The Active wire is coloured brown (or red), the Neutral wire is coloured blue (or black) and the Earth wire is coloured yellow-green (or green).

The colours in brackets are for Australia's previous cable colour code standard, which is still used in older but none-the-less legal devices.

Electrical Appliances and Tools

Grounded appliances. We have many grounded 230V appliances in our homes today such as electric toasters, frypans, washing machines and clothes dryers. Most of these appliances have exposed metal surfaces and therefore will use a three-core power cable with a 3-pin plug. These are *grounded* appliances. The earth wire is used as a safety ground to provide protection in the event of a fault condition occurring within the appliance. Generally speaking, appliances used inside the home are reasonably well cared for.

Conversely, the 230V power tools used in workshops can experience a very different life! That's because power tools can be dropped and damaged. They can be carried by the power cable. The power cables can be repeatedly trampled on, run over, crushed, items by heavy items dropped onto them, harmed by sharp objects or even severed. The cables and plugs can be damaged by pulling on the cable instead of the plug or by pulling the plug sideways in a socket. The cable can get caught around an object and be freed by pulling the cable a little harder! The plugs or plug pins can become damaged or crushed. In summary, the cable and plug on a power tool may suffer a very hard life and may need to be replaced during the life of the tool.



Ungrounded Appliances. There are appliances and tools which are certified as "*double-insulated*" and will carry the approved "*double-insulated*" logo shown above. *These devices are ungrounded and do not use an earth wire*, so the power cable is a two-wire cable which connects to a two-pin power plug. Sometimes you may see double-insulated appliances and tools fitted with a three-pin plug, but in such cases, the earth pin is not wired.

Note: Double-insulated appliances and tools should never be fitted with an earth wire! It will bypass the double-insulation safety protections and safety certifications, which are there for your protection!!

Australia's MEN System

As shown on the diagram on the last page, all house Neutral wiring connects to the Neutral buss in the switchboard, and all house Earth wiring connects to the Earth buss. The Neutral buss is linked to the Earth buss with the Neutral link. Finally, the Earth buss connects to a metal Earth stake which has been driven 1.5m into moist ground outside the premises. That's the way Australia's domestic electricity supply is set up at the premises. It's known as a *Multiple Earthed Neutral* (MEN) system and is designed to minimise the risk of electrocution in the presence of a fault condition by providing *multiple* low-resistance paths to neutral/ground for redundancy. In fact, the earth stakes at all the houses in your street are connected to *your* earth stake via your incoming neutral wire. Thus, *multiple earthed neutral*.

The MEN system was assigned as the standard for Australia in 1980. Australian homes built before 1980 will have been wired in accordance with one of the previous electrical standards, of which there were several used throughout the country.

Electric Shock

It's not the *voltage* that produces an electric shock. It's the *current* which flows *through* the body as a result of the voltage. That's why RCDs are designed to trip at a specified *current*.

Earth Stake Safety Warnings

As already noted, the Earth buss at the switchboard is connected to an outside earth stake at the premises. This earth connection is a critically important component of the electrical safety provided by the MEN system and should never be tampered with in any shape or form. An electrician is the only person who should work with electrical system earth stakes.

Thus, there are two fundamental safety rules regarding earth stakes:

1. **NEVER** disconnect the wire which connects to an Earth stake for any reason whatsoever, whether it be for a microsecond or a millennium! *An electrician is the only person who should do that.*
2. Should you find the wire that connects to an Earth stake has been disconnected, **NEVER** touch the wire or attempt to reconnect it to the Earth stake. **IMMEDIATELY** turn off the power at the master switch and call an electrician.

Unknown Device

Before plugging in an appliance whose electrical condition is unknown, check and then recheck that the tool or appliance and its power cable and plug appear sound and physically undamaged. If in any doubt about the safety or integrity of the device, test it with an appliance tester before using it.

Summary

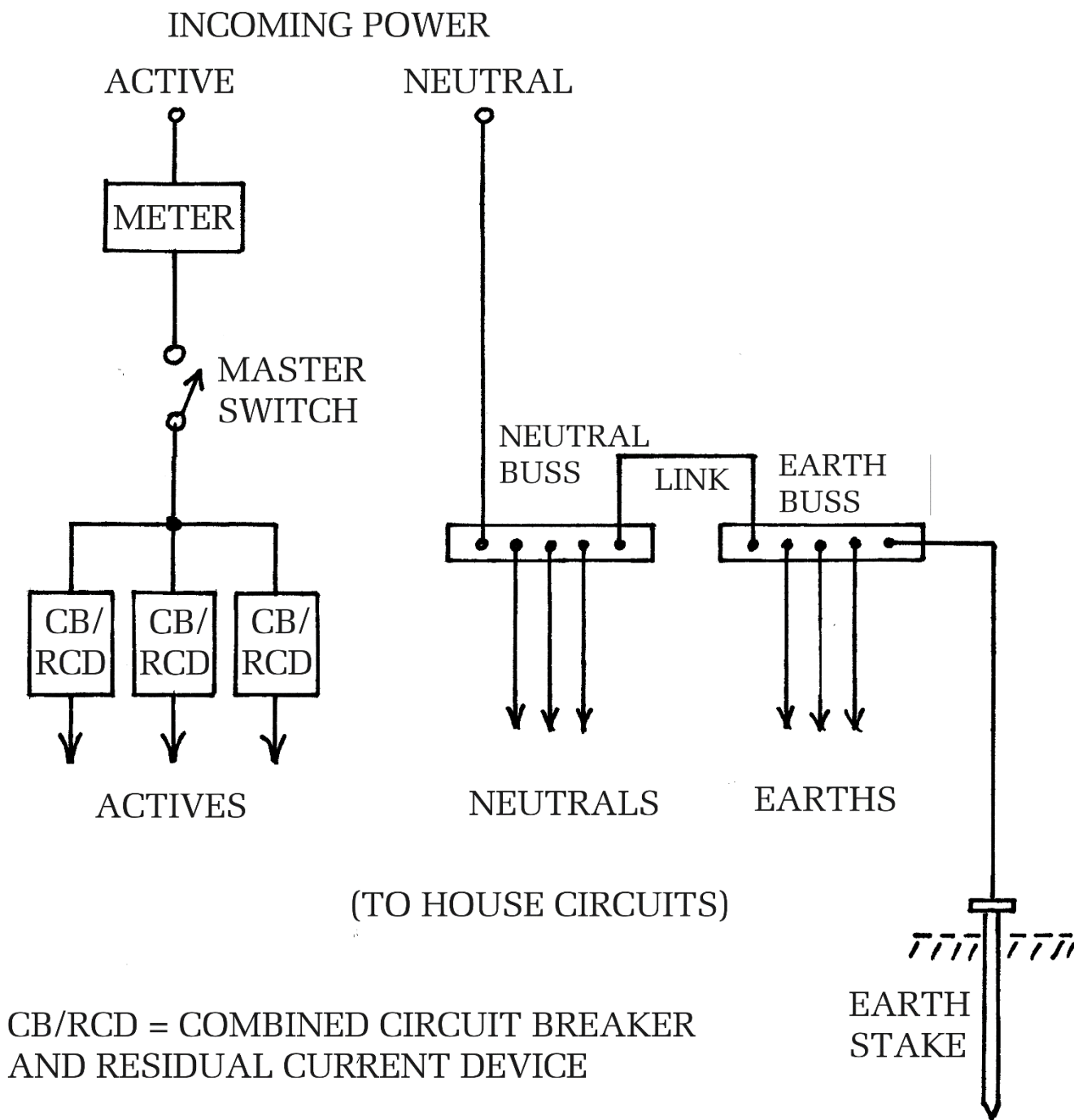
Incorrect wiring or poor wiring practices can result in your death or the death of someone else. Check and then recheck!!

Don't be complacent concerning electrical safety practices in the belief that the RCD will protect you! Take the view that "there is no RCD", and act accordingly!

NEVER work on live circuits unless it's necessary, and **ONLY** if you're a qualified electrician.

If you have any doubts whatsoever about the safety of your electrical wiring practices or the safety of a tool or appliance, seek expert advice **before plugging it in!** Don't just play it safe with electricity. Play it VERY safe. If in any doubt whatsoever, **don't plug it in!**

AUSTRALIA'S DOMESTIC POWER INSTALLATION



4. WIRE CRIMPING, CRIMPS AND CRIMPING TOOLS

Background:

When doing vehicle electrical wiring work, the goal is to do it once and do it correctly. We don't wish to revisit our work in the future to repair it!



Insulated crimps

The most “popular” reason to revisit electrical work is to attend to poorly crimped wiring connections because of either incorrect operator technique or a poor quality crimping tool. These manifest themselves in ongoing vehicle problems and frustrations, especially when diagnosing problems because of intermittent wiring connections.

Insufficiently tightened crimps will result in poor mechanical performance and poor electrical conductivity. Overtightened crimps may improve some aspects of electrical performance, but it can result in damage to the crimp body or wire strands, causing a reduction in crimp tensile strength and/or vibration resistance.

There is a science to wire crimping. If you follow the right methods, you'll end up with a quality connection. For example, it's important to remove the correct amount of insulation from the wire - if too little has been removed, there won't be enough wire to extend fully through the wire barrel grip so as to have a small amount exposed at the connector end of the barrel. This will affect the connection quality.

Another issue is failing to insert all the wire strands inside the wire barrel. This usually happens when the wire cut is not clean, which results in the wires spreading out, impacting the strength of the connection. Many crimping problems can also be traced back to the type of crimp terminal used, as well as the size of the wire — smaller wires tend to be more difficult to insert into the wire barrel due to their lack of strength.

When stripping the insulation off the end of the wire in readiness for attaching a crimp terminal, ensure:

1. The strands are cut squarely across the wire (makes it easy to insert the strands into the wire barrel);
2. No strands are cut off (reducing the effective cross-sectional area of the wire and adding to the difficulty of inserting the strands into the wire barrel), and
3. The strands are not nicked (a precursor to the strands breaking).

You can usually tell that there's a problem with wire crimping just by looking at it. Some common problems include poor condition conductors. If they're not in a strong, clean condition, then they won't bond correctly with the crimp metal. On a longer-term basis, crimping problems can lead to discoloration, abrasion, and burning. If you notice any of these issues, then you'll need to redo the wiring connection.

It's much easier to prevent a wire crimping problem in the first place rather than trying to fix the issue later. The first step towards ensuring that you don't face any issues is to use the correct wire crimping tool. It can sometimes seem that you can use any crimper when you're wiring, but this isn't the case. The right tool will depend on the wire that you're trying to terminate. Most crimping tools are designed with a particular wire gauge in mind.

Wire crimping is something that can look easy, but there's value in learning the correct techniques. Without following the correct methods, you may run into a whole host of issues.

Crimped vs Soldered Connections:

At its core, wire crimping is preferred over soldering because of the quality of the connections that it offers. However, if an incorrect method is used, the connection will suffer.

A correctly crimped terminal creates a metal-to-metal colloidal (cold weld or forged) bond at the surfaces between the wire and the terminal. If done correctly, no void (space) remains between the strands of the wire and between the strands and the crimp, and the two separate metals are cold forged as one. This ensures very low resistance, mechanically strong and long-life connections. This is the preferred joining mechanism.

If we were to use solder to join the wire to the crimp, the current flowing must pass through the solder, and the resistivity of 63/37 solder is around ten times the resistivity of copper, exacerbating the vehicle's wiring resistances! Remember, series resistances are additive.

Soldering a wire causes wicking, which is when the solder is drawn up into the strands towards the insulation. You can attach a heat sink to the stranded wire as you solder to reduce the wicking effect, but you can't really stop it. This produces a rigid boundary between the flexibility of the copper strands and the rigidity of the solder. No strain relief is provided at that boundary, resulting in a wire that breaks after a few flexes. If you have crimped properly, which forms cold welds between a clean wire and a clean terminal, the joint will be more reliable than solder by some orders of magnitude. If you crimp poorly, and just squeeze everything together, don't expect good results.

As another point of "comfort", consider that the aerospace and aviation industries have been using crimped connections for many decades! The AMP Corporation developed crimped or solderless connections during the Second World War as a way of achieving much greater reliability, quality and consistency of electrical connections when compared to soldered connections. A spacecraft is a high vibration environment which uses crimped and not soldered connections. *Crimping works if you use the right tool and the correct technique and is ultra reliable. Soldering decreases this reliability.*

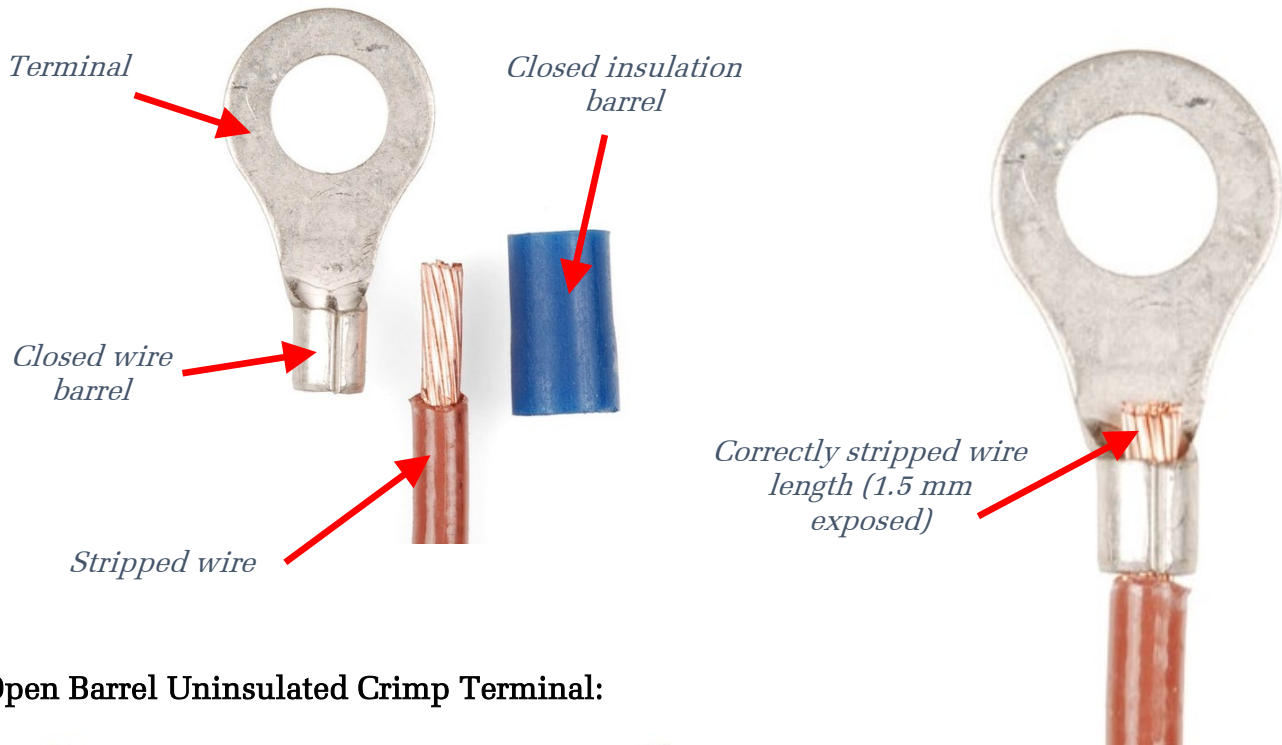
Crimped Terminal Strength:

One is usually unable to remove a crimped terminal by hand from a wire if it has been crimped correctly! Have a practice run. Test every crimp in this manner to confirm its integrity before putting it to use. If the crimp comes off the wire, *something* is wrong! It's not cold welded. Using the right technique won't only ensure that the connection is strong. It will help the connection to remain in place for many years.

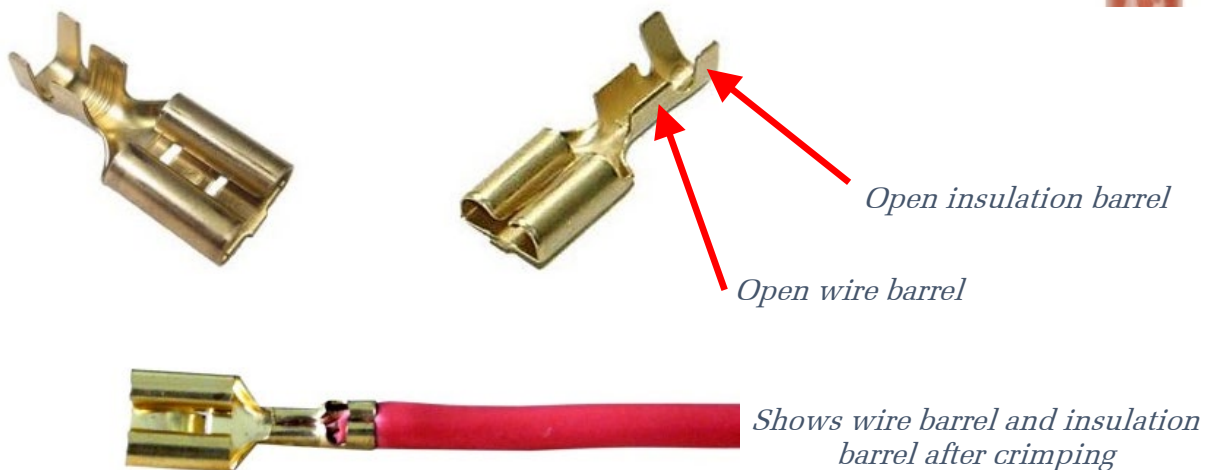
In summary, achieving high quality crimp connections requires (1) a high quality crimping tool; (2) a correctly-adjusted crimping tool; (3) professional-quality crimp terminals and (4) correct operator technique! A large variety of crimping tools are available, and they are not all of the same quality. Many are poorly designed and/or manufactured, and if these are used, the result can be an abject failure, after which the blame is usually passed onto the crimps as being the cause of the problem. Otherwise the badly crimped connections may stay hidden until they start to impact on the operation and reliability of the vehicle.

Important: A cold weld bond requires *true* metal-to-metal contact between the molecules of the copper wire strands and the molecules of the crimp terminal. Any dirt or oxide layers on either part will prevent the cold welding of the parts, resulting in a faulty connection!

Parts of a Closed Barrel Insulated Crimp Terminal:



Open Barrel Uninsulated Crimp Terminal:



Wire Barrel (Open or Closed type):

Purpose: Provides electrical and mechanical connection of the wire's conductors.

Insulation Barrel (Closed type):

Purpose: Provides strain relief for the wire.

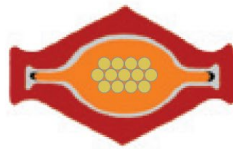
Requires a more relaxed crimp than the wire barrel crimp.

Provides no electrical connection or appreciable mechanical strength.



Too Loose

1



Too Tight

2



Optimum

3

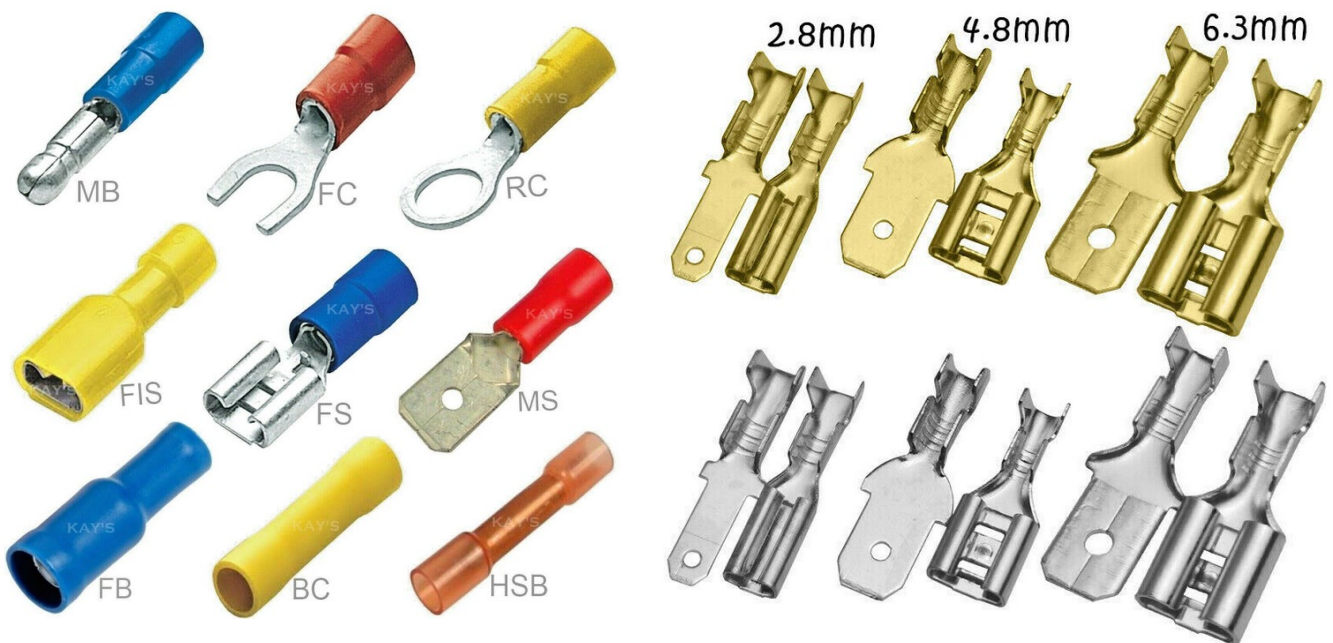
If the crimping of the closed insulation barrel is:

Too loose: No mechanical support or strain relief for the wire because of insufficient contact between the insulation barrel and the wire insulation.

Too tight: Insulation barrel digs into the wire insulation, reducing the strain relief and support and can break wire strands.

Optimum: The wire insulation is held firmly by the insulation barrel. Slight indenting of the wire insulation. Good mechanical support and strain relief.

A Range of Crimps and Lugs:



A range of crimps – insulated and non-insulated



A range of lugs (solid-formed crimps)

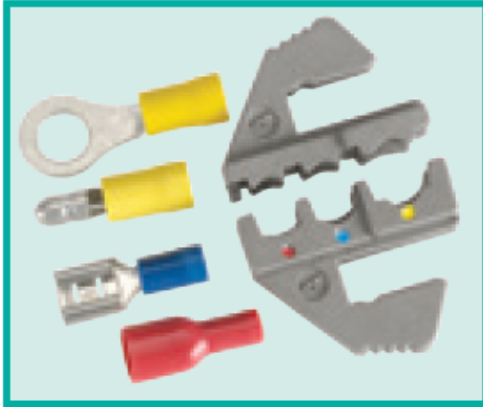
Example of an Excellent Quality Crimping Tool:

As an example only, the writer uses the Narva 56513 professional crimping tool, shown at Fig. 1.

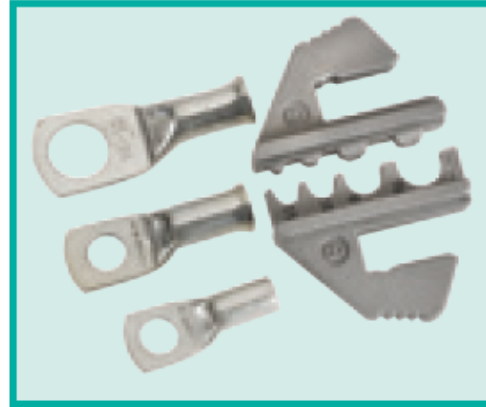


Fig. 1

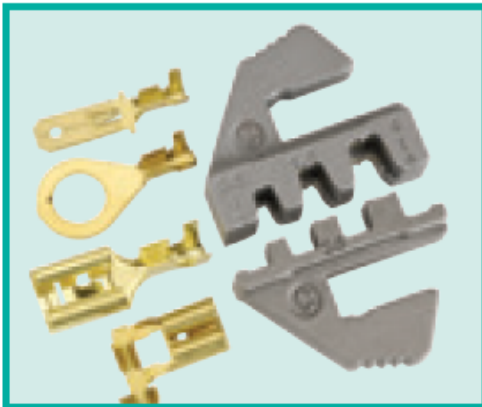
This ratchet crimping tool is supplied with four interchangeable heads (jaws/dies) to suit the four different groups of crimp terminals shown in Fig. 2. This adds great flexibility to the tool. Fig. 1 shows the tool with Head A fitted, which accommodates the common red, blue and yellow insulated crimp terminals. The heads may be quickly swapped over.



P/No. 56532-A (Head A)
Suitable for blue, red and yellow insulated terminals



P/No. 56532-B (Head B)
Suitable for cable lugs sizes 2.5mm² – 16mm²



P/No. 56532-C (Head C)
Double crimp, suits non-insulated terminals



P/No. 56532-I2 (Head I2)
Single crimp, suits MC4 and non-insulated terminals

Fig. 2

The advantage of the ratchet crimper is that it demands that the crimping process be fully completed *before* it can be released. (It does have an override mechanism.) This is to ensure the *correct* pressure has been applied in a measured and repeatable manner to form the intended cold weld bond. Remember, a *correctly* crimped connection with the correct tool provides a cold weld bond between the wire strands and the terminal. **They are not simply squeezed together, as is done by many cheap “crimping” tools.**



Fig. 3

Fig. 3 at left shows the form of construction of the lower jaw for the red-blue-yellow crimps, shown as Head A in Fig. 2. Use the red dot section for red crimps, the blue dot section for blue crimps and the yellow dot section for yellow crimps.

A benefit of the Narva crimper above is the diverse range of crimps which may be accommodated in a single tool in a reliable, repeatable, professional manner. Still, you can pay even more for a good crimper, but you can also pay *so very much less... and achieve results which are commensurate with the cost of the tool!*

With correct operator technique, a *good* crimping tool will provide a perfectly crimped connection time after time.

Don't use a crimp with a wire barrel bigger than necessary for the job, as the cold-weld bond may not be formed as intended and the wire may have some movement or looseness in the barrel.

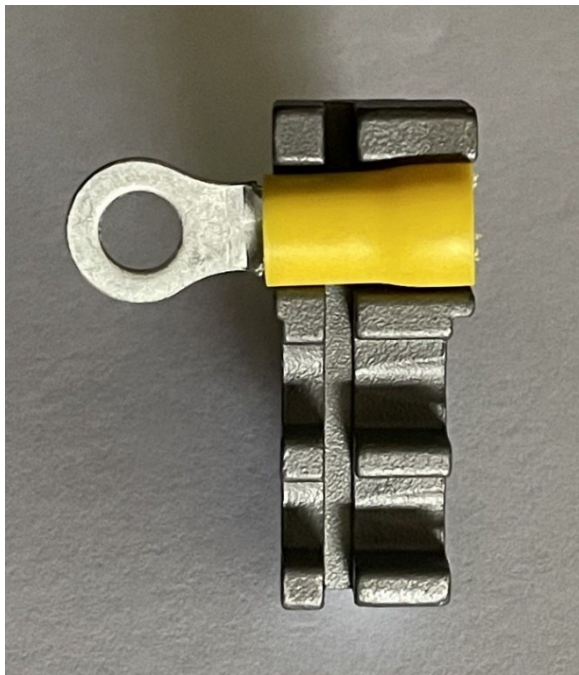


Fig. 4

Fig. 4 at left shows Fig. 3 with a yellow crimp in position, just as it would be if it was fitted in the crimping tool.

From Figs. 3 and 4, each jaw consists of two sections of different widths. The narrower section on the left is the part which crimps the wire barrel around the conductor, and the wider section on the right crimps the strain-relief part of the crimp – the yellow insulator - around the wire's insulation.

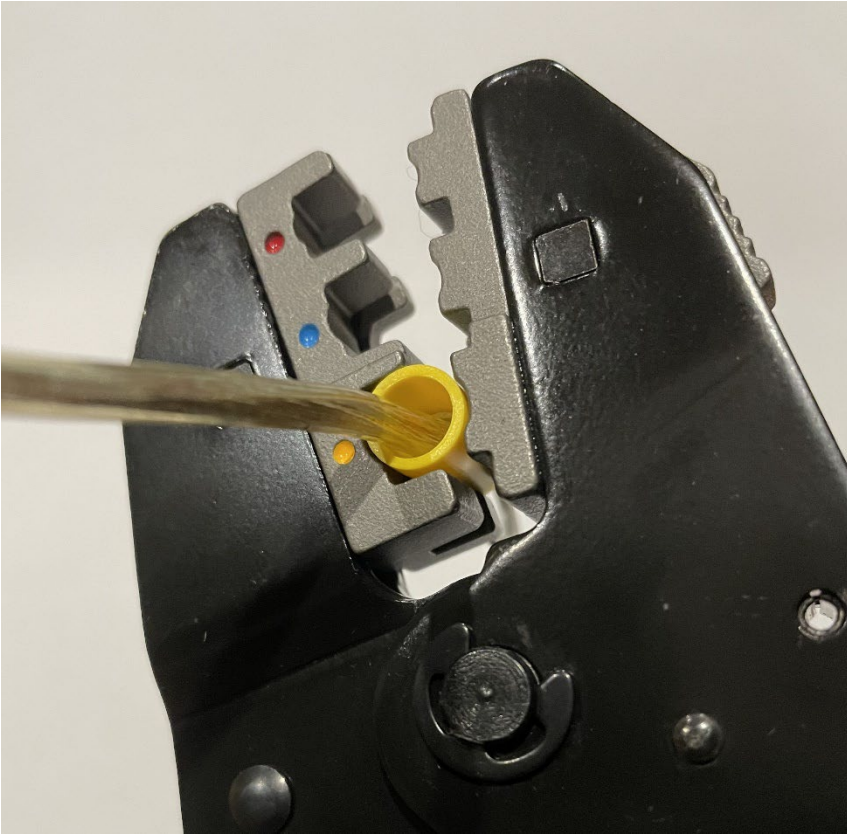


Fig. 5 at left shows the left side of the tool, with a crimp in position in the tool and with a wire inserted, ready to be crimped.

Note that the wire enters the crimp from the left side of the tool.

Fig. 5



Fig. 6 at left shows the right side of the crimping tool, and shows the crimp terminal in position, ready to be crimped.

Also note the end of the wire extends outwards from the end of the wire barrel by perhaps 1.5 mm and has been cut squarely and cleanly. This provides visual confirmation that the wire has passed fully through the wire barrel.

Fig. 6



Fig. 7

Fig. 7 at left shows a closeup of the left side of the tool and the left end of the yellow insulator barrel. Note that the crimp is positioned in the tool so that the **left end of the insulator is lined up exactly with the left face of the jaws.** This positioning is *vital*.



Fig. 8

Fig. 8 at left shows a closeup of the right side of the tool and the right end of the yellow insulator. Again, note that the crimp is positioned in the tool so that the **right end of the insulator is lined up exactly with the right face of the jaws.** Again, this is vital.

In fact, when the yellow crimp is correctly positioned in the tool, the two ends of the yellow insulator barrel line up exactly with the two faces of the jaws. This is the confirmation that the crimp is in the correct position for crimping.

With the crimp in this position, the tool is tightened and released to complete the crimping procedure.

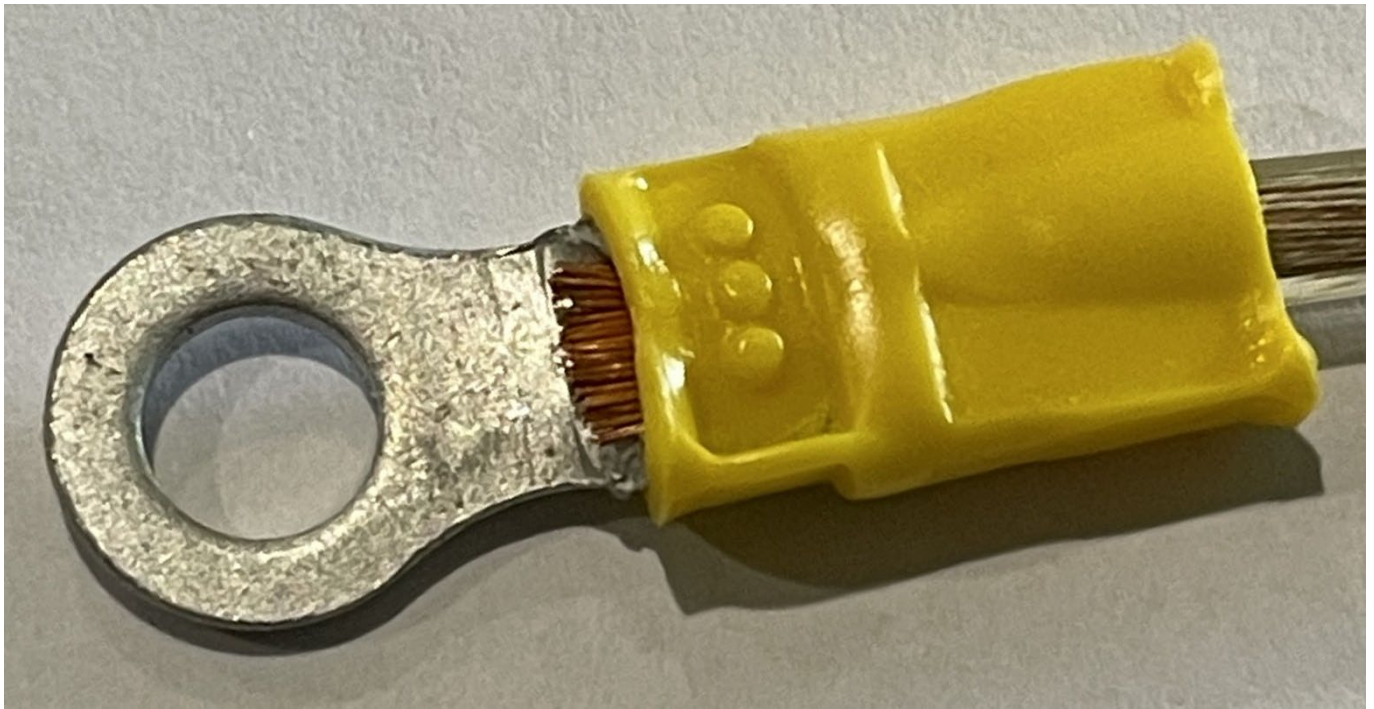


Fig. 9

Fig. 9 shows the upper face of a correctly crimped insulated terminal. The copper wire is extending out from under the yellow insulator, the ends of the copper strands are cleanly and evenly cut squarely across the wire, the (narrow) wire barrel crimper to the left has done its job, leaving its three dots (indicating the correct (yellow) crimping slot in the tool was used to crimp the terminal), and the (wide) insulation crimper to the right has also done its job by the pattern formed on the yellow insulation barrel.



Fig. 10

Fig. 10 shows the lower face of the crimped terminal. The yellow insulation barrel has been correctly formed around the wire barrel and the connecting wire.

Conclusion:

A high-quality crimping tool will pay for itself many times over because of the **quality, integrity, reliability and long-life** of the electrical terminations you create with it.

5. VALVE OVERLAP

Valve overlap occurs when both the inlet and exhaust valves are open at the same time between the exhaust and inlet strokes. Valve overlap begins (the inlet valve starts to open) as the piston approaches TDC on the exhaust stroke and continues until just after TDC when the exhaust valve closes. The correct overlap is essential for optimal performance, requiring endless hours of engineering design. When both valves are open simultaneously, a drop in cylinder pressure occurs. Overlap is the ability of inlet and exhaust flows to affect each other due to pressure waves that vary with load and engine rpm. Overlap is well balanced at TDC on most engines. Piston motion has the greatest effect on airflow the further from TDC that valve overlap exists.

The theory behind valve overlap is that since the inlet valve is open slightly, departing exhaust gas flow creates a vacuum that aids in pulling fresh air-fuel mixture into the cylinder, without any of the intake mixture passing into the exhaust system (scavenging). It also aids in the fresh mixture helping to displace the leftover exhaust gases that remain in the cylinder.

As the piston travels from BDC, pushing exhaust gases from the cylinder through the open exhaust valve, the inlet valve begins to open before the piston reaches TDC. As the piston approaches BDC on the inlet stroke, the pressure differential across the cylinder is almost zero; however, the air-fuel mixture continues to fill the cylinder a small amount, enhancing the airflow. As mixture flows into the cylinder, it gains velocity, creating a column of air contained within the inlet port and inlet manifold. This airflow is column inertia. The cylinder continues to fill due to the inertia present in the air-fuel mixture that is already moving. This principle of airflow allows the inlet valve to be held open as the piston is starting its climb back up the cylinder on the compression stroke.

The exiting exhaust gases increase the mixture intake, exceeding that which would usually enter the engine from piston travel alone. Valve overlap also helps purge the spent exhaust gases by the incoming fresh mixture until the exhaust valve closes. Delaying the inlet valve from closing allows the cylinder to pack as much of the fresh mixture as possible into the cylinder. Inertia causes the air molecules to pack together more tightly, especially at higher rpm, thus creating a ram-air effect.

Increased overlap is beneficial at higher speeds and loads due to exhaust pressure waves drawing in the intake mixture while both valves are open. Large overlap at lower speeds results in higher emissions as the mixture flows directly into the exhaust, never burning. At idle, increasing valve overlap produces a rougher idle by pulling slowly moving exhaust gases back into the inlet manifold, diluting the incoming fresh mixture. Improved exhaust scavenging and induction system breathing work together to improve volumetric efficiency. Improving breathing is achieved by smoothing inlet and exhaust passages, using tuned inlet and exhaust manifolds (to maximize ram effect and scavenging) and a low back-pressure exhaust.

Scavenging is the process of using a column of air to create a low pressure behind it to assist in removing any remaining burned gases from the combustion chamber and replacing those gases with new mixture. As the exhaust stroke ends and the inlet stroke begins, both valves are open together for a short time, which is the overlap.

As the exhaust gases leave the combustion chamber, the flow tends to continue, creating a low pressure behind it that helps to draw the intake of the fresh mixture into the cylinder. At the same time, the movement of the mixture being pushed by atmospheric pressure into the combustion chamber also helps to push the remaining exhaust gases out. It also aids in the fresh mixture helping to displace the leftover exhaust gases that remain in the cylinder.

6. CALCULATING CRANKING COMPRESSION PRESSURE

Background:

When diagnosing motor vehicle engine performance issues, useful information can sometimes be obtained by measuring the cranking compression pressure (CCP) in each cylinder and comparing the results with the manufacturer's specifications. Such pressure readings should be taken when the engine is hot, using a known-accurate pressure gauge, and commencing with a fully charged battery to ensure the same cranking speed is applied for each cylinder test. Crank the engine with the ignition coil disconnected, all spark plugs removed and the throttle held wide open. Use a pressure gauge with a *threaded metal adapter* which screws into the spark plug socket. Don't use a gauge with a press-and-hold rubber fitting as these almost invariably never *fully* seal.

Sometimes the manufacturers don't specify the cranking compression pressure, in which case an estimate of the expected pressure will be needed. To do this, we firstly need to calculate the effective stroke (ES) and the Dynamic Compression Ratio (DCR), which involve some basic mathematics. This involves some algebra, geometry and trigonometry.

CALCULATING EFFECTIVE STROKE (ES)

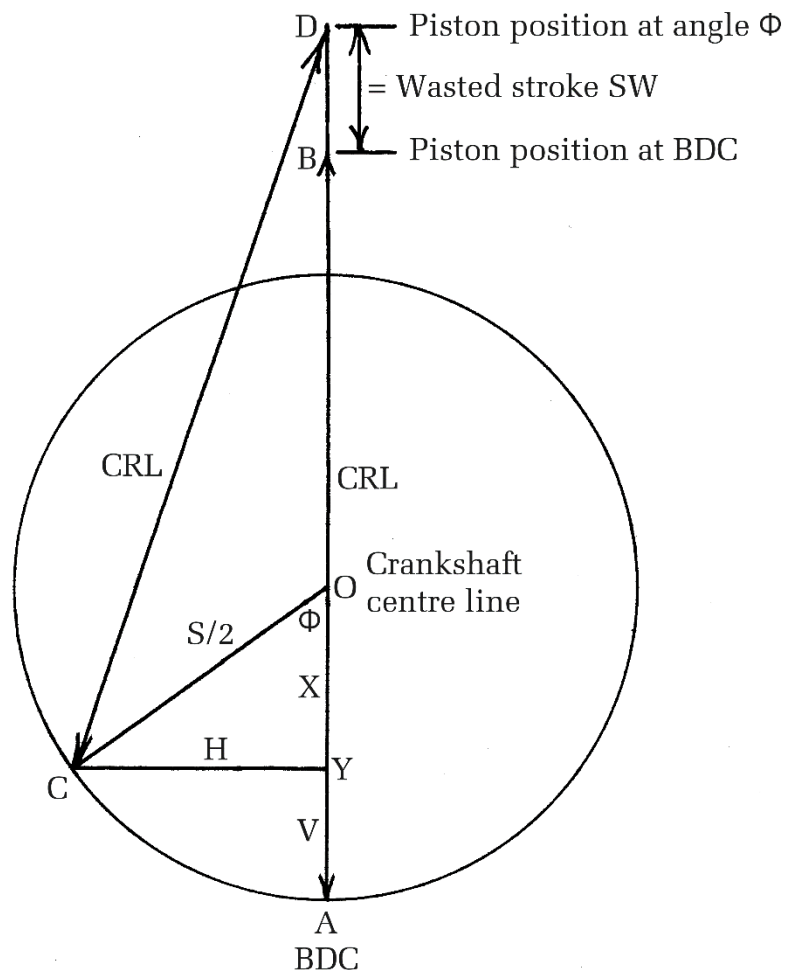


Fig. 1

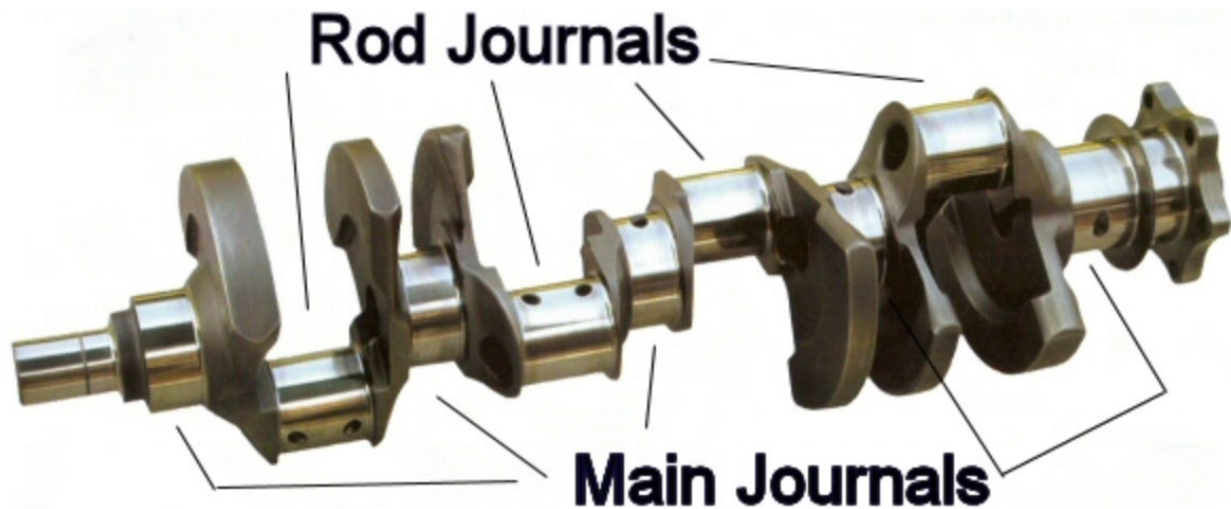


Figure 2

Variables Specified by the Vehicle Manufacturer:

S = Stroke = diameter of the circle

B = Bore of cylinder

Φ = Crankshaft angle after BDC when the inlet valve closes (IVC)

CRL = Conrod Length (centre-to-centre) = AB, CD

CR = Compression Ratio

Other Variables:

$S / 2$ = conrod throw = radius of circle = OC

V = vertical displacement of conrod at angle Φ = AY

H = horizontal displacement of conrod at angle Φ = CY

SW = Wasted Stroke

SE = Effective Stroke = $S - SW$

P = Atmospheric pressure

Effective Stroke? Whaaaaaat?

The reciprocating engine uses a piston moving in a straight line, and the crankshaft converts the reciprocating motion into rotary motion. Consider Fig. 1. The crankshaft centreline is located at the circle centre O, and the circle represents the path of rotation of the conrod big end around the crankshaft. Thus the diameter of the circle represents the stroke. The piston and cylinder are at the top of the figure. The vertical line through the circle centre is a line showing the path of the piston as the crankshaft rotates.

The line AB (with arrow heads) represents the conrod of length CRL when the piston is at BDC (Bottom Dead Centre).

Angle Φ is the crankshaft angle after BDC at which the inlet valve closes, so the line CD (with arrow heads) is the position of the conrod when the inlet valve closes and the compression of the fuel mixture begins.

The point B represents the piston position in the cylinder when at BDC, and the point D represents the piston position in the cylinder at the crankshaft angle Φ after BDC. The lineal piston travel between points B and D on the compression stroke is the stroke distance SW, which represents the “wasted” portion of the stroke, where no mixture compression occurs because the inlet valve is still open. To repeat, the inlet valve remains open until the conrod has moved to C and the piston has moved to D.

To determine the cranking compression pressure (when the piston is at TDC), we firstly need to determine the effective stroke SE, i.e., the length of stroke during which the mixture is being compressed. In short, the effective stroke SE equals the specified engine stroke S less the “wasted” stroke SW.

Most engines don't close the inlet valve at BDC of the inlet stroke. They utilise the momentum of the fuel mixture travelling through the inlet manifold to maximise the amount of fuel mixture moved into the cylinder on the inlet stroke. Thus, the inlet valve is closed at some angle Φ after BDC. This also means the mixture is not being compressed as much as is possible because of the wasted stroke SW. Thus Φ becomes one of the engine designers' trade-off parameters for performance manipulation. (Do they seek a later closing angle (larger Φ) to gain more fuel mixture drawn in, at the cost of reduced mixture compression, or close the inlet valve earlier (smaller Φ) to gain more mixture compression?)

(Not only does the inlet valve closing at angle Φ affect the cranking compression pressure, the subject of this section, it also has a profound effect on the performance of the engine, which will be discussed further on.)

Now calculate the Effective Stroke (SE), which is the actual stroke distance where mixture compression takes place. To repeat, the Effective Stroke SE = Stroke S - Wasted Stroke SW. Effective Stroke is the lineal piston stroke distance between the inlet valve closure point and TDC. This *is* where the mixture compression occurs.

From Fig. 1:

$$\sin \Phi = H / (S/2), \text{ so } H = S/2 \sin \Phi$$

$$\cos \Phi = X / (S/2), \text{ so } X = S/2 \cos \Phi$$

$$V = (S/2) - X = (S/2) - S/2 \cos \Phi = S/2 (1 - \cos \Phi)$$

Now calculate SW, the “wasted” piston travel (stroke) distance between the point B and the point D.

From the right triangle DCY,

$$CRL^2 = H^2 + (CRL - V + SW)^2$$

$$\text{i.e., } CRL^2 - H^2 = (CRL - V + SW)^2$$

$$\text{and } \text{SQRT}(CRL^2 - H^2) = CRL - V + SW$$

$$\text{so } SW = \text{SQRT}(CRL^2 - H^2) - CRL + V$$

$$= \text{SQRT}(CRL^2 - (S/2 \sin \phi)^2) - CRL + S/2 (1 - \cos \phi)$$

$$\text{Now, } SE = S - SW$$

$$= S - \text{SQRT}(CRL^2 - (S/2 \sin \phi)^2) + CRL - S/2 (1 - \cos \phi)$$

$$\text{Now, as } S - S/2 (1 - \cos \phi) = S/2 (1 + \cos \phi),$$

$$\text{Effective Stroke } SE = CRL - \text{SQRT}(CRL^2 - (S/2 \sin \phi)^2) + S/2 (1 + \cos \phi)$$

Consider an example using the M28/1 engine in the Citroen 2CV. It has a stroke S of 7cm, a bore B of 7.4cm, the inlet valve closes at $\phi = 49.25^\circ$ after BDC, the conrod length CRL is 13 cm (approx.) and the (static/specified) compression ratio CR is 8.5:1. Assume atmospheric pressure is 14.7psi.

From the equation above, $SE = 6.058\text{cm}$ and $SW = 0.942\text{cm}$.

Now continue the steps to calculate the cranking compression pressure CCP :

$$\text{Swept cylinder volume: } VS = B^2 \times S \times \text{Pi} \div 4 = 301.058\text{cc}$$

$$\text{Effective swept cylinder volume: } VSE = B^2 \times SE \times \text{Pi} \div 4 = 260.54\text{cc}$$

$$\text{Combustion chamber volume: } VC = VS \div (CR - 1) = 40.14\text{cc}$$

$$\text{Compression Ratio: } CR = (VS + VC) \div VC = 8.5:1 \text{ (as given)}$$

$$\text{Dynamic Compression Ratio: } DCR = (VSE + VC) \div VC = 7.49:1$$

$$\text{Cranking compression pressure: } CCP = (DCR^{1.2} \times P) - P = 150.01 \text{ psi}$$

The calculated CCP above should not be taken as being universally *exact* because the exponent value 1.2, the ratio of specific heats for the combustion gases at the temperatures present, is dependent on the temperature *rise* of the fuel mixture due to compression and the temperature *fall* due to heat lost to the cylinder. However, it may be used as a reliable indicator for general assessment purposes.

Under ideal conditions (no heat transfer to or from the combustion gases, the ratio of specific heats would be 1.4, but a lower value, generally between 1.2 and 1.3 is used, since the amount of heat lost will vary among engines, and is based on design, size and materials used. The reduced figure provides two corrections. It corrects for the temperature rise caused by compression, and corrects for the temperature fall due to heat lost to the cylinder. The corrections, which affect the cranking compression pressure, affect cylinder pressure in opposite directions, but do not fully counter each other. However, an engine with high static compression ratio and late inlet valve closure (low DCR) will have a cranking compression pressure similar to an engine with lower static compression ratio but earlier inlet valve closure (higher DCR).

Some Geometrical Realities:

1. Piston speed is faster when the conrod is positioned closer to its top of travel (TDC) than when positioned closer to its bottom of travel (BDC).
2. Longer conrods will have the piston closer to the TDC point for crankshaft angles in the upper half circle.
3. Shorter conrods will have the piston closer to the BDC point for crankshaft angles in the lower half circle.
4. With shorter conrods, the piston moves slower around BDC than around TDC, allowing more fuel mixture to be captured with the same inlet valve closing angle.

It is important to understand that the motion of the piston when the conrod is in the upper half circle **is not symmetric** with the motion of the piston when the conrod is in the lower half circle. The piston movement when the conrod moves around the upper half circle is substantially MORE than the piston movement when the conrod moves around the lower half circle. Refer Fig. 3.

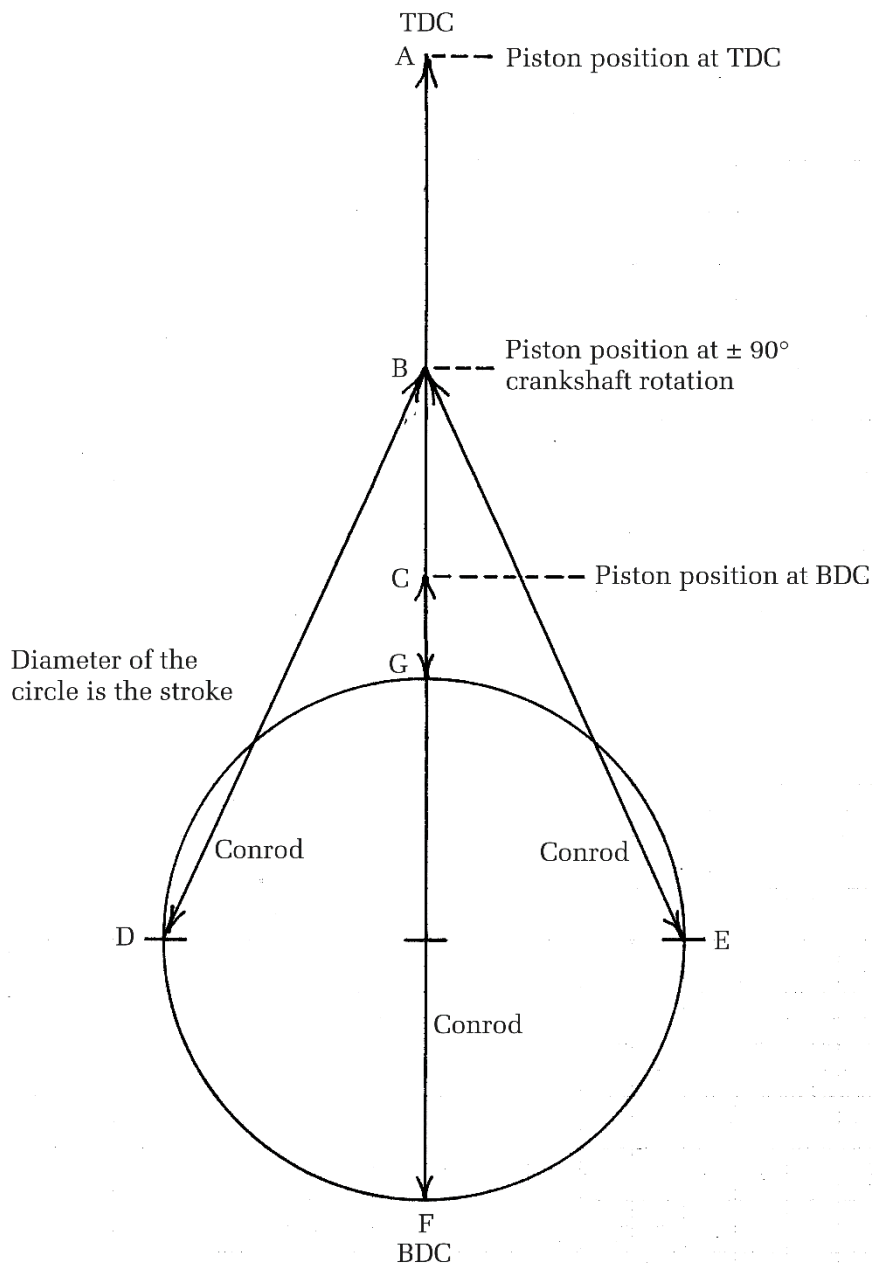


Fig. 3

From Fig. 3, when the crankshaft is at BDC, the conrod is shown by distance FC and the piston is at position C. When the crankshaft is rotated $\pm 90^\circ$, the conrod is shown by distances DB and EB and the piston is at position B. When the crankshaft is at TDC, the conrod is shown by distance GA and the piston is at position A.

It may be observed that piston movements CB and BA are not equal, confirming the piston movement when the conrod is in the upper half circle of rotation is greater than the piston movement when the conrod is in the lower half circle of rotation.

Significance of Inlet Valve Closing Angle:

Say the power stroke has just completed and the piston is moving back up the cylinder on the exhaust stroke. The inlet valve is closed and the exhaust valve is open. As the piston moves upwards, it starts pushing the spent combustion gases out the open exhaust valve.

The momentum of the high temperature gases flowing out the exhaust valve creates a low pressure area in the combustion chamber, so while the exhaust valve is still open, the inlet valve is opened. The gas moving out the exhaust valve will start pulling fresh mixture into the cylinder. If it's timed right, the exhaust valve will close just as all the spent gases are expelled and just before fresh mixture is drawn out the exhaust port.

As the piston goes down on its inlet stroke, it creates a low pressure area in the cylinder because the fuel mixture can't fill the space as fast as the piston is dropping. When the piston hits the bottom of the inlet stroke, the pressure in the cylinder is much lower than atmospheric. Because of this, mixture is still rushing in through the inlet valve as the piston starts up the cylinder on its compression stroke. As the piston travels upwards in the cylinder, it starts to create a high pressure wave at the piston face as it pushes the mixture upwards, while the low pressure area in the combustion area is still drawing in mixture from the inlet valve. In summary, we have a low pressure zone in the upper cylinder space and a high pressure zone being pushed upwards by the piston face.

The goal is to close the inlet valve at the point where these two pressure zones meet and equalize (in the upper cylinder area). Why? *Because as much fuel mixture as possible has been taken into the cylinder by that stage (for the RPM), maximising the volumetric efficiency.* The inlet valve is then closed *before* any of the mixture can be pushed back out the inlet valve by the piston. That's why the inlet valve is closed at some critical angle part way through the compression stroke. As already noted, later closing of the inlet valve means the dynamic compression ratio is not as high as it would otherwise be.

Remember, if the movement of the mixture into the cylinder is fast enough, we can pack more mixture into the cylinder using the inertia of the incoming mixture than the piston could ever pull in based on the vacuum force alone.

Closing the inlet valve early or late for a given ideal timing period will result in a corresponding reduction in the intake mixture being trapped in the cylinder. Closing the inlet valve early reduces the mixture available to the cylinder, while if the valve is closed later, some of the mixture will flow back into the inlet manifold due to it being pushed by the piston. Either of these events will result in a corresponding reduction in the air fuel mixture within the cylinder. Thus the optimum angle for Φ .

In summary, the dynamic compression ratio is higher with earlier inlet valve closing, and lower with later inlet valve closing. Regardless, the dynamic compression ratio is always lower than the static compression ratio due to the inlet valve being closed at some angle Φ after BDC.

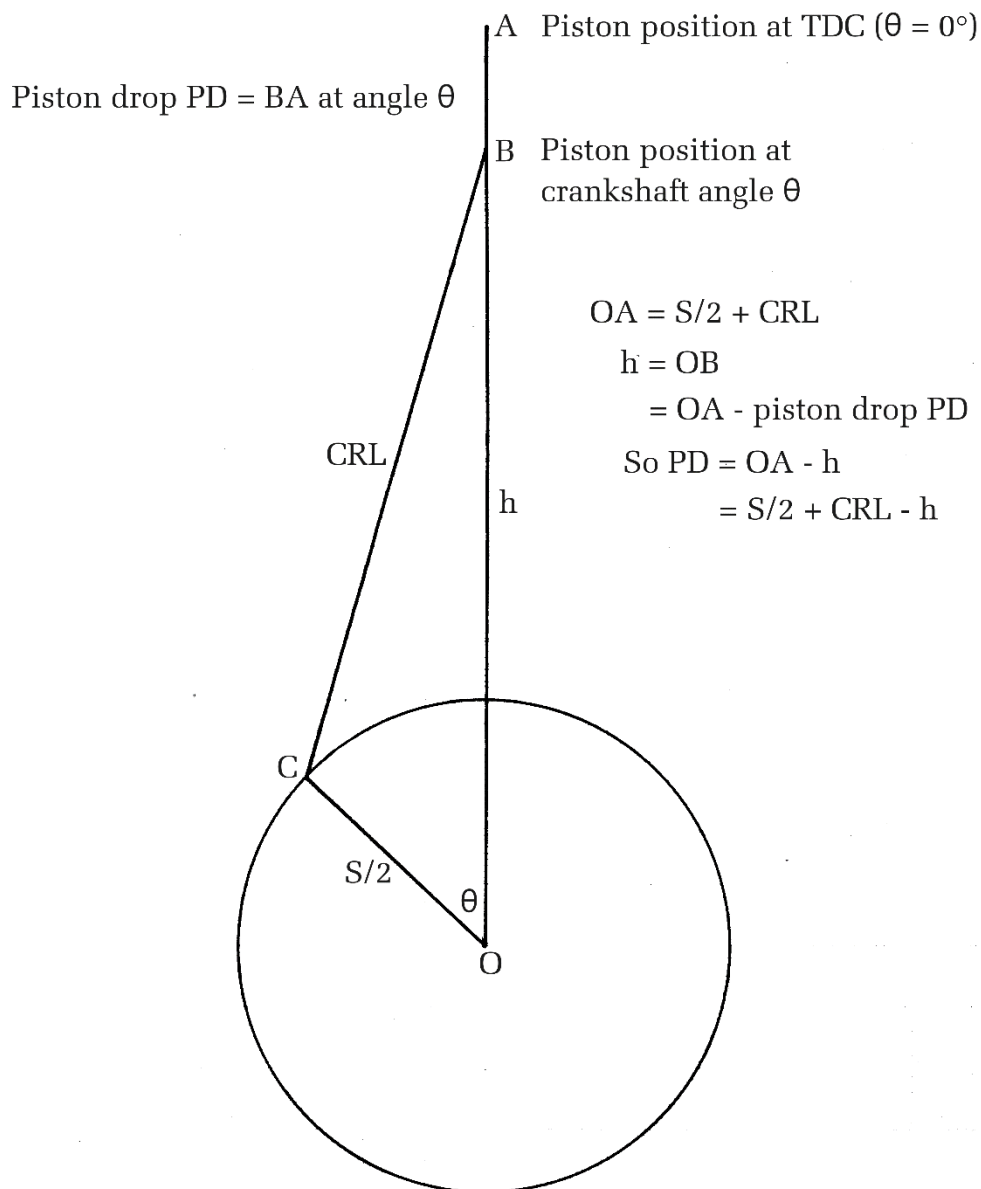
In conclusion, we can make an excellent estimate for the expected cranking compression pressure using the formulas above.

7. CALCULATING PISTON DROP FOR A GIVEN CRANKSHAFT ANGLE

This section derives the mathematical formula to calculate the piston drop PD from the TDC position when the crankshaft is rotated by θ degrees from TDC. Refer to the figure below.

CRL = conrod length, S = stroke, θ = crankshaft angle with respect to TDC. PD = piston drop. The circle diameter is the stroke.

In the figure, when the crankshaft is at TDC ($\theta = 0$ degrees), the piston is at position A. The distance OA is the sum of half the stroke ($S/2$) and CRL. When the crankshaft is turned through the angle θ so the conrod is at position C, the piston is drawn down the cylinder bore to position B. The piston drop is the distance BA. The purpose here is to derive the formula to calculate the piston drop BA via calculating the distance OB (h), i.e., $PD = OA - h$, where the points COB are the vertices of a triangle of sides $S/2$, CRL and h. This involves some algebra, geometry and trigonometry.



From the figure above:

Inputs:

Crankshaft angle θ from TDC

Stroke S

Conrod length CRL

Applying the Cosine Rule to the triangle COB to solve for side h,

$$CRL^2 = (S/2)^2 + h^2 - 2(S/2) h \cos(\theta)$$

$$CRL^2 = (S/2)^2 + h^2 - S h \cos(\theta)$$

$$\text{i.e., } h^2 - S \cos(\theta) h + ((S/2)^2 - CRL^2) = 0$$

Using the Quadratic solution to solve for the side h = OB:

$$\text{Let } a = 1, b = -S \cos(\theta), c = (S/2)^2 - CRL^2$$

$$\begin{aligned} h &= (S \cos(\theta) \pm (S^2 \cos^2(\theta) - 4((S/2)^2 - CRL^2))^{1/2}) / 2 \\ &= S/2 \cos(\theta) \pm \text{SQRT}((S/2)^2 \cos^2(\theta) - (S/2)^2 + CRL^2) \\ &= S/2 \cos(\theta) \pm \text{SQRT}((S/2)^2 (\cos^2(\theta) - 1) + CRL^2) \\ &= S/2 \cos(\theta) \pm \text{SQRT}(CRL^2 + (S/2)^2 (\cos^2(\theta) - 1)) \end{aligned}$$

But $\text{SIN}^2(\theta) + \text{COS}^2(\theta) = 1$, so $\text{COS}^2(\theta) - 1 = -\text{SIN}^2(\theta)$

$$\begin{aligned} \text{then } h &= S/2 \cos(\theta) \pm \text{SQRT}(CRL^2 - (S/2)^2 \text{SIN}^2(\theta)) \\ &= S/2 \cos(\theta) \pm \text{SQRT}(CRL^2 - (S/2 \text{SIN}(\theta))^2) \end{aligned}$$

$$\text{so Piston Drop PD} = S/2 + CRL - h$$

$$\text{so Piston Drop PD} = S/2 + CRL - S/2 \cos(\theta) \pm \text{SQRT}(CRL^2 - (S/2 \text{SIN}(\theta))^2)$$

An example:

For crankshaft angle $\theta = 30^\circ$, stroke S = 100mm, conrod length CRL = 150mm, the piston drop is 8.797 mm.

8. CALCULATING CRANKSHAFT ANGLE FOR A GIVEN PISTON DROP

This is the inverse of the formula derived in the previous section. Here, for a given piston drop, we derive the formula to calculate the required crankshaft angle θ . This involves some algebra, geometry and trigonometry.

Inputs:

Piston Drop PD

Stroke S

Conrod length CRL

Applying the Cosine Rule to the triangle COB in the previous figure,

$$CRL^2 = (S/2)^2 + h^2 - S h \cos(\theta)$$

Now we solve for the crankshaft angle θ .

$$S h \cos(\theta) = (S/2)^2 + h^2 - CRL^2$$

$$\text{So } \cos(\theta) = ((S/2)^2 + h^2 - CRL^2) / (S * h)$$

$$\text{Thus } \theta = \text{ACOS}(((S/2)^2 + h^2 - CRL^2) / (S * h))$$

$$\text{But as Piston Drop } PD = S/2 + CRL - h,$$

$$\text{Then } h = S/2 + CRL - PD$$

$$\text{so } \theta = \text{ACOS}(((S/2)^2 + (S/2 + CRL - PD)^2 - CRL^2) / (S * (S/2 + CRL - PD)))$$

An example:

For Piston Drop PD = 10 mm, Stroke S = 100 mm, CRL = 150 mm,
the crankshaft angle $\theta = 32.073^\circ$.

9. THE BASIS OF SOLDERING

Background:

Traditionally, common solder is made of a mixture of tin and lead. One of the secrets of good soldering is using the correct amount of heat, as different solders have different melting points which depends on the tin / lead ratio. Tin melts at 232°C and lead melts at 327°C.

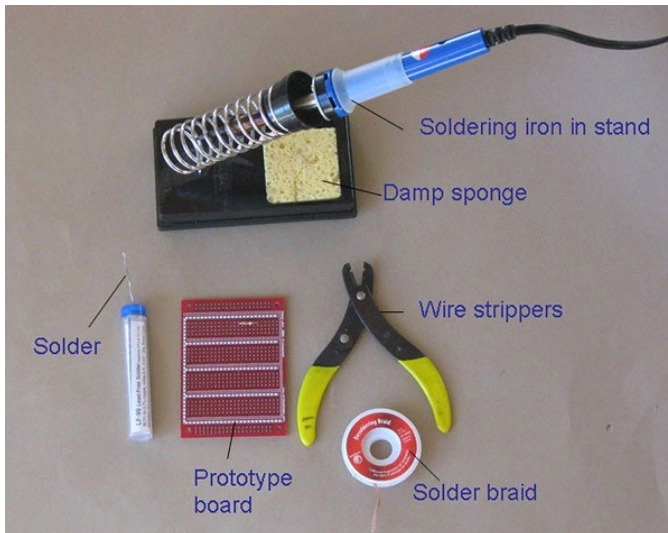


Photo 1. Basic soldering station equipment.



Photo 2. A high-quality soldering station.

Solder used in electrical/electronic assembly and repair consists of 63% tin and 37% lead, known as 63/37 solder. (In industry, solder component percentages are percentages by weight.) This solder melts at 183°C, the lowest melting point for a tin / lead solder alloy. More follows. Photo 1 at left shows the basic items needed for soldering work. The key items are a good quality, temperature-controlled soldering iron, a damp sponge to wipe the tip on to keep it clean, and of course, the solder.

Tin/lead solder is corrosion resistant and has good electrical properties. It also creates solder joints with mechanical strength appropriate for electronic devices.

Photo 2 at left shows an example of a high-quality soldering station. The soldering iron is a low voltage, temperature-controlled, temperature-adjustable iron, managed by the power unit on the left. A wide range of tips is available to meet a wide range of soldering tasks and situations, per Photo 3 below.



Photo 3. Examples of the types of tips available for the soldering iron in Photo 2.

Phase Diagram:

Fig. 1 below presents the basic phase diagram for a tin / lead solder alloy mixture.

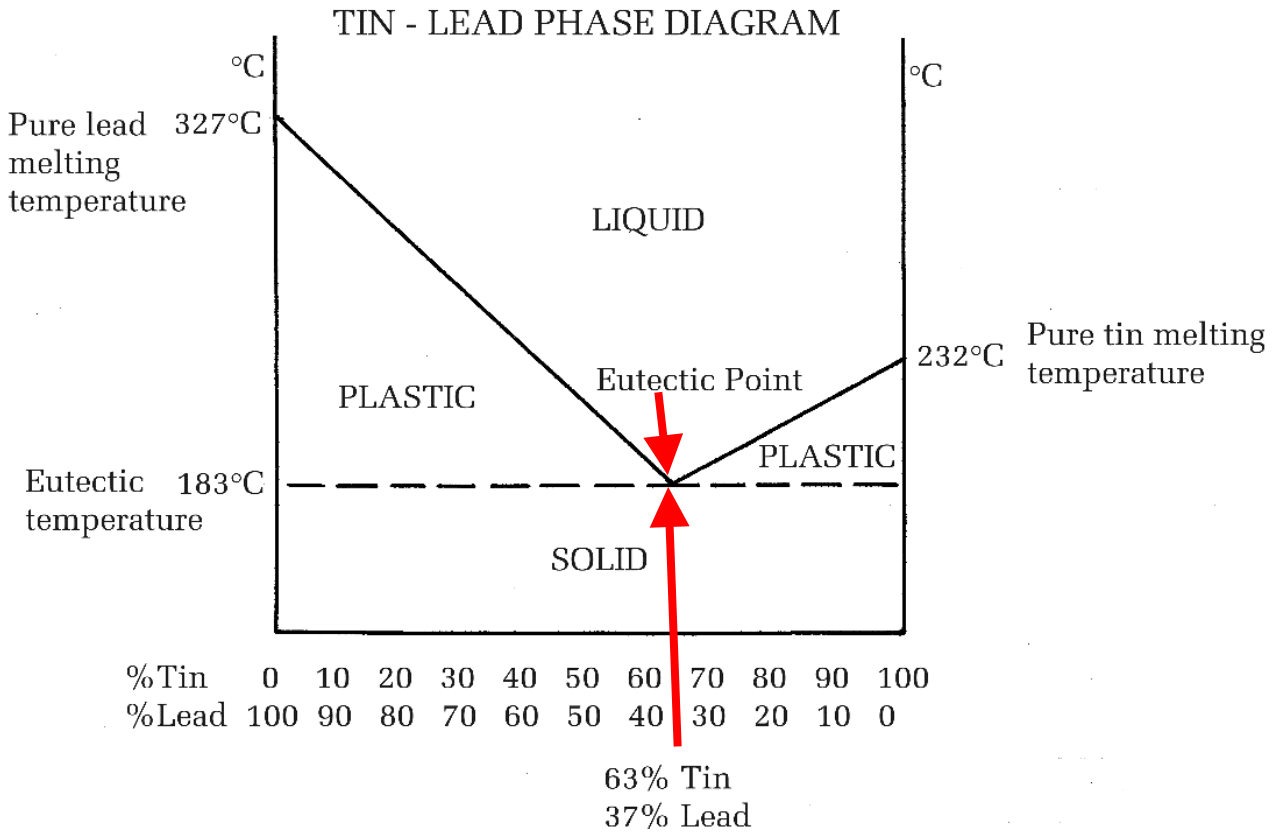


Fig. 1. Basic Tin-Lead Phase Diagram.

Observations from Fig. 1:

1. The vertical axes are temperatures in °C.
2. The horizontal axis shows percentages of tin and lead (by weight) in the solder over the range from 0% to 100%, with 100% (pure) lead on the left end and 100% (pure) tin on the right.
3. The left vertical axis is marked with the temperature at which lead melts, which is 327°C, while the right vertical axis is marked with the temperature at which tin melts, which is 232°C.
4. Starting from the left axis, the pure lead side of the figure, pure lead melts at 327°C as noted. Moving to the right, i.e., as more tin is added to the mixture, the temperature at which the solder melts starts to fall. At the special ratio of 63% tin / 37% lead, known as the eutectic ratio, and shown in the figure by the red arrows, the melting temperature of the solder is at its lowest value, which is 183°C. This is known as the eutectic temperature. More follows.
5. Moving further towards the right side of the figure, the melting point of the solder starts to rise as the percentage of tin continues to increase. At the pure tin axis on the right side, pure tin melts at 232°C.

Phase Transition:

What is phase transition? The figure shows three phases (states) of tin / lead solder.

1. Solid phase: Below the eutectic temperature of 183°C, the solder is solid, *regardless of the tin / lead ratio*.
2. Liquid phase: At the eutectic ratio of 63% tin / 37% lead, at any temperature above the eutectic temperature, the mixture is liquid (molten) tin and lead, as shown in the figure.
3. Left-side plastic phase: Consider the tin / lead ratios on the left of the eutectic ratio. As the mixture is heated above the eutectic temperature, the mixture firstly passes through a plastic (mushy, pasty) phase, where the mixture is comprised of solid lead and molten tin-lead. As the temperature is further increased, the point is reached where the entire mixture becomes liquid.
4. Right-side plastic phase: Consider the tin / lead ratios on the right of the eutectic ratio. As the mixture is heated above the eutectic temperature, it enters a plastic phase comprised of solid tin and molten tin-lead. As the temperature is further increased, the point is reached where the entire mixture becomes liquid.

The Eutectic Ratio:

At the eutectic ratio (63% tin / 37% lead), you will note an interesting phenomenon. There is no plastic phase between the solid phase and the liquid phase. A eutectic blend of metals *melts and solidifies at the exact same temperature*, while non-eutectic metals or alloys have different liquid and solid temperatures.

And why is this of interest? This ratio is the one and only tin / lead ratio where the solid and liquid phases meet, i.e., where the solid and liquid phases occur and coexist *at the same temperature*, which is 183°C. This ratio provides the most rapid solid to liquid transition when being heated and the most rapid liquid to solid transition when being cooled. The former assists in minimising the heat applied to the job, while the latter assists by quickly solidifying the solder.

The liquid to solid transition typically occurs very quickly, perhaps in under a second for practical hand-soldering tasks. When soldering a wire or component, it's a very short time between the solder's liquid phase, created by the heat of the soldering iron, and the solid phase, created by the cooling of the solder. Even so, the wires being soldered *must remain still* during this period until the solder hardens. Make sure there is no movement or stress on the joint during the cooling period, else what is known as a dry joint or cold joint will result. More follows. A correctly soldered joint will have a bright and shiny appearance.

Non-Eutectic Tin / Lead Ratios:

At non-eutectic tin / lead ratios, when cooling, the solder's liquid phase passes into a plastic phase before it cools sufficiently to reach the solid phase. This transition could take several seconds, and the wires being soldered have to be kept *absolutely* still, otherwise a dry joint will result.

A dry joint has a rough, irregular appearance and looks dull instead of bright and shiny. If the wires move, i.e., the solder is disturbed while the solder is in its plastic phase, the solder will be deformed, and the deformation will remain when the solder hardens. Dry joints can have poor electrical properties and poor mechanical strength, creating a weak, problematic electrical connection. The answer? Apply the flux and soldering iron again and retry. The trained eye can spot a dry joint.

Still, holding the wires still for several seconds can be challenging, but is necessary when using non-eutectic solder. Non-eutectic solders tend to have a dull, grainy appearance.

The Reality Today:

Although 63/37 solder is the ideal solder for electronic components and wiring because of its eutectic properties, locating a supplier of it can be difficult, and when found, is usually very costly.

A commonly available solder with very similar characteristics consists of 60% tin / 40% lead and is available from the usual electronic supply houses. The consequences of using 60/40 solder instead of 63/37 solder can be drawn from Fig. 1. The job and the solder have to be heated to a slightly higher temperature, 190 °C, to completely liquify the solder, and the solder has to cool to 183°C to completely solidify. This means there is a small plastic phase between these two temperatures, *so greater care is needed to hold the job steady so as not to produce a dry joint*. A properly soldered joint using 60/40 solder will still have a bright and shiny appearance, but just allow an extra second or two for it to solidify before moving the wires.

Wetting Action:

A metal bonding action occurs when hot solder comes into contact with the surface of say copper wire. The solder melts and then penetrates the surface of the wire. The tin and lead molecules in the solder blend with the copper molecules in the wire to form a new alloy, one that's part copper, part tin and part lead. This bonding action is called wetting, and it forms the inter-metallic bond between the parts being joined.

Wetting can only occur if the surface of the copper wire is free of contamination and oxide film that forms when copper is exposed to air. Also, the solder and the joint surfaces have to reach the proper temperature. Although the surfaces to be soldered may *look clean, there is always a thin film of oxide covering it*. For a good solder bond, surface oxides must be removed during the soldering process using flux.

Fluxes:

Reliable solder connections can only be accomplished with truly clean surfaces. Solvents can be used to clean the surfaces before soldering but are insufficient on their own due to the extremely rapid rate at which oxides form on the surface of heated metals. To overcome this unwanted oxide film, it becomes necessary to use materials called fluxes in electronic soldering.

When heated, the flux is activated and starts to remove the oxides, preventing them from interfering with the soldering process. The flux suspends the oxides in solution and floats them to the top. Flux also promotes wetting and aiding the molten solder to spread and adhere to the metal surfaces by reducing the surface tension of the solder and allows the solder to flow smoothly and evenly, creating strong and reliable soldered joints.

Flux is very corrosive at solder melting temperatures and accounts for the flux's ability to rapidly remove metal oxides. In its unheated state, however, rosin flux is non-corrosive and non-conductive and thus will not affect electronic circuitry. The fluxing action removes the oxides, carrying them away, and prevents the formation of new surface oxides, allowing the solder to form the desired inter-metallic bonds while the metal surfaces being soldered are protected from the air.

Flux typically comes in the form of paste or liquid, or as a core of flux within the solder wire (the origin of the term, rosin-cored solder). The electronic supply houses can supply paste or liquid fluxes. Add a smidgeon at each soldering step to aid the smooth flow of the solder and to ensure all surfaces are wetted so that a sound soldered joint results.



Photo 4. Example of Rosin flux in paste form

The writer uses the paste form which comes in a small container, such as shown in Photo 4 at left.

Flux must melt at a temperature lower than the solder to do its job before the soldering action commences. It will activate rapidly. It's necessary that the flux is melted so it flows onto the work surfaces and not simply heated by the soldering iron tip. This is to ensure the full benefit of the fluxing action is achieved. If insufficient flux is used, the resulting soldered joint will be problematic at best! If necessary, add a little extra flux paste and heat the joint again.

High Current Situations:

Some electrical connections carrying very high currents can't be made with ordinary tin / lead solder because the heat generated by the joint resistance would melt the solder. Some types of starter motors use brushes where the metal braid is soldered, and high melting point silver solder prevents the solder being melted. Solder made of 5% tin / 93.5% lead / 1.5% silver is commonly used, which has a (liquid) melting point of 301°C.

Some Hints:

When soldering, apply the solder to the joint, not to the iron. The iron and the solder should be applied simultaneously to the joint. Keep the soldering iron tip clean by wiping the tip on a moist sponge.

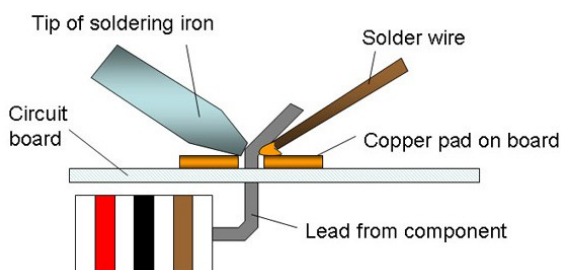


Fig. 2

Fig. 2 at left shows the principle of applying the soldering iron tip and the solder to the joint being soldered, which in this case is a lead of a fixed resistor being soldered to a copper pad on a printed circuit board.

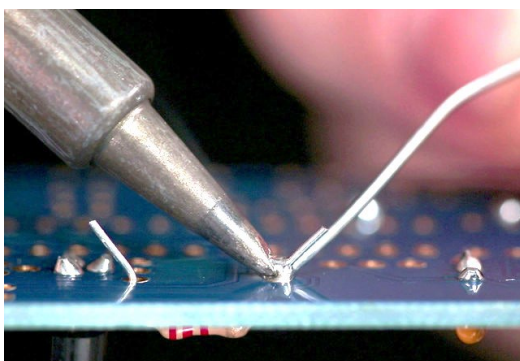


Photo 5

Photo 5 at left is a photo of the situation depicted in Fig. 2 above.

The two key factors in quality soldering are time and temperature. Generally, rapid heating is desired. If heat is applied for too long, the flux may become used up, the work can become overheated and surface oxidation can become a problem.

Always use rosin-core solder, never acid-core solder.

Flux is not a general bench cleaning material and is not a part of a soldered connection. It merely aids the soldering process. After soldering, any remaining flux should be removed, and alcohol is a good solvent for the job. A toothbrush is an excellent tool for applying the alcohol and brushing the excess flux away.

Attached Tables:

Shown at Fig. 3 is a table which lists the solid to plastic temperatures and the plastic to liquid temperatures (i.e., the plastic phase boundary temperatures) for various solder alloys using tin and lead (by weight). It includes the temperatures of melted (pure) lead, melted (pure) tin and the 63/37 eutectic mixture.

The table at Fig. 4 lists the plastic phase boundary temperatures for various solder alloys of tin, lead, silver and other metals (by weight). The table shows a total of nine eutectic combinations, such as the eighth row with 1% tin / 97.5% lead / 1.5% silver, which has a eutectic temperature of 309°C.

Both tables show temperatures in °C and °F.

Summary:

The tin / lead eutectic ratio has the unique property of an instantaneous transition between the liquid and solid phases, greatly assisting electrical soldering tasks. This is the key reason why 63/37 (or 60/40) solder has been used for decades to make electrical wiring connections and component assemblies.

Like many trade skills, soldering is a skill learnt by doing, and the **only** way to gain the necessary abilities to become proficient at soldering is to practise, practise and... yes, practise!

Solder Alloy Melting Temperature

METAL WEIGHT PERCENT				MELTING TEMPERATURE	
TIN	LEAD	SILVER	OTHER	SOLIDUS	LIQUIDUS
				DEGREES C	DEGREES F
0	100			327	621
2	98			316-322	601-611
5	95			301-314	574-597
10	90			268-302	514-576
15	85			225-290	437-554
20	80			183-280	361-536
25	75			183-268	361-514
30	70			183-258	361-496
35	65			183-247	361-477
38	62			183-242	361-468
40	60			183-238	361-460
45	55			183-225	361-440
48	52			183-218	361-424
50	50			183-214	361-420
55	45			183-203	361-397
58	42			183-195	361-388
60	40			183-190	361-374
63	37			183	361
65	35			183-186	361-367
70	30			183-192	361-377
75	25			183-195	361-383
80	20			183-202	361-396
85	15			183-209	361-408
90	10			183-216	361-421
95	5			183-224	361-434
100	0			232	450

Fig. 3

METAL WEIGHT PERCENT				MELTING TEMPERATURE	
TIN	LEAD	SILVER	OTHER	SOLIDUS DEGREES C	LIQUIDUS DEGREES F
60	36	4		179-246	354-475
61.5	35.5	3		179-227	354-440
62	36	2		179-189	354-372
62.5	36.1	1.4		179	354
10	88	2		268-299	514-570
5	93.5	1.5		296-301	564-574
	97.5	2.5		305	581
1	97.5	1.5		309	588
	94.5	5.5		304-365	579-689
			100 In	156	313
49.1			50.9 In	120	248
50			50 In	120-123	248-253
52			48	120-122	248-252
	30		70 In	160-174	320-345
	40		60 In	174-185	345-365
	50		50 In	180-209	356-408
	60		40 In	195-225	383-437
	70		30 In	238-253	460-487
15.5	32		52 Bi	95	203
43	43		14 Bi	144-163	291-325
95		5		221-245	430-473
96.5		3.5		221	430
96		4		221-229	430-444
98		2		221-226	430-439
95.5		0.5	4.0 Bi	216-221	421-430
95			5 Sb	233-240	450-464
99.3			0.7 Cu	227-240	441-464
42			58 Bi	138	280
20			80 Au	280	536

Fig. 4

10. LIST OF ARTICLES BY THE WRITER

The articles written by the writer, listed below, may be freely downloaded from either of the following club websites by clicking on the adjacent links and locating the articles. Both websites maintain the latest revisions of the articles. Before using the articles, please ensure the latest revisions are being used, as the articles are updated on an as-required basis by the writer and given new revision numbers.

Citroen Classic Owners' Club of Australia: [Technical Articles](#)

Citroen Car Club of Victoria: [Tech Tips](#)

1. 2CV 40-Litre Fuel Tank
2. 2CV API GL-4 Gearbox Oil
3. 2CV Battery Charging Circuit
4. 2CV Battery Problems Solved
5. 2CV Brake Saga
6. 2CV Buyer's Questions
7. 2CV Carburettor Cover Screws
8. 2CV Carburettor Jets and Adjustments
9. 2CV Engine Problems
10. 2CV Fuel Filter
11. 2CV Fuel Gauge and Battery Meter
12. 2CV Gearbox Output Hubs
13. 2CV Gearbox Unwinding Debacle
14. 2CV Hard Luck Stories
15. 2CV Headlights Improvement
16. 2CV Ignition Coil
17. 2CV Knife Edges Replacement
18. 2CV Low Oil Pressure Beeper and Lights On Beeper
19. 2CV Maintenance - Part 1 of 2
20. 2CV Maintenance - Part 2 of 2
21. 2CV Oil Breather
22. 2CV Oils and Maintenance Advice From Burton
23. 2CV Points Ignition Reinstallation
24. 2CV Roof Rack
25. 2CV Secondary Choke Butterfly Adjustment
26. 2CV Spare Parts to Carry
27. 2CV Valve Clearance Adjustment
28. 2CV Workshop
29. Better Fuel Hose Clamps – **applies to all vehicles**
30. Better UHF CB Car Radio Performance – **applies to all vehicles**
31. Ignition Coil Ballast Resistors – **applies to all vehicles**

FINAL STATEMENT

My acknowledgement and grateful appreciation is given to *Shop4Fasteners* and *PB Swiss Tools* from which information on Phillips and Pozidriv screws and screwdrivers has been obtained.
Used with permission.

My acknowledgement and grateful appreciation is given to *Automobiles Citroën* for the use of the 2CV data tables included herein.

My acknowledgement and grateful appreciation is given to *Technic Inc* for the use of the two Solder Alloy Melting Temperature tables.
Used with permission.

My acknowledgement and grateful appreciation is given to CDX Learning Systems for the section on valve overlap, drawn from the book titled *Automotive Engine Performance*.

My acknowledgement and grateful appreciation is given to the web sites from which photos/drawings/diagrams have been sourced.

If material copyrighted by others has been inadvertently used in this document without permission, then upon being advised, the writer will remove the material immediately.

This article may be updated in the future and assigned a new revision number.

Before using the information in this article, ensure the latest revision is being used.

If you have questions about the information in this article, if you find errors or incorrect statements, if you have suggestions for improvement, or should you wish to republish this article in your club magazine, please - contact the writer at: gdennes@gmail.com

The hosting or republishing of this article without the formal consent of the writer is not authorised and will constitute an infringement of copyright.

Copyright © Graeme Dennes 2023, 2024